

PAPER • OPEN ACCESS

3rd Annual Applied Science and Engineering Conference (AASEC 2018)

To cite this article: 2018 *IOP Conf. Ser.: Mater. Sci. Eng.* **434** 011001

View the [article online](#) for updates and enhancements.

Preface

The 3rd Annual Applied Science and Engineering Conference (AASEC) 2018 organized by Technology and Vocational Education Study Program, School of Postgraduate Studies, Universitas Pendidikan Indonesia (UPI) and UPI Publication Center, and is jointly organized with Universitas Negeri Jakarta (UNJ), Environmental Engineering Universitas Trisakti, Universitas Syiah Kuala (UNSYIAH), Universitas Negeri Surabaya (UNESA), Politeknik Negeri Malang (POLINEMA), Sekolah Tinggi Teknologi Garut (STT Garut), Universitas Islam Negeri Sunan Gunung Djati Bandung (UIN SGD), Universitas Kanjuruhan Malang (UNIKAMA), Universitas Muhammadiyah Sidoarjo (UMSIDA), Universitas Wijaya Kusuma Surabaya (UWKS), and Universitas Warmadewa. Promoting its theme “Ideas for Sustainable Green Energy”, the conference was held on 18 April 2018 at Grand Tjokro Hotel, Bandung, Indonesia.

This year, the conference invited a keynote speaker, Dr. Abdulkareem Shafiq Mahdi Al-Obaidi from Taylor’s University, Malaysia and four invited speakers from different countries with a variety of expertise as follows: 1) Dr. Eng Tedi Kurniawan from Universiti Malaysia Pahang, Malaysia; 2) Dr. Lala Septem Reza from Universitas Pendidikan Indonesia; 3) Dr. Eng. Topan Setiadipura from National Nuclear Energy Agency, Indonesia; and 4) Dr. Eng. Farid Triawan from Tokyo Institute of Technology Japan/ Sampoerna University, Indonesia. Both the keynote speaker and invited speakers are academics and practitioners in the field of green sustainable energy with numerous works on international publication.

There are 353 papers published in the proceedings of the 3rd AASEC 2018. The papers discuss several fields comprising mathematics, physics, computer science, material science, chemistry, biology, pharmacology, sport science and technology, management science, mechanical engineering, chemical engineering, civil engineering, electrical engineering, electronics engineering, material engineering, environmental engineering, industry engineering, information engineering, computer and communication engineering, and architecture. All the published papers have been through a series of rigorous review process to meet the requirements and standards of international publication.

We would like to thank each co-host for the efforts to give significant contribution particularly on paper selection. We would also like to acknowledge vice rector on research, business, and partnership affairs of Universitas Pendidikan Indonesia for the endless support to the conference. Last but not least, we would like to express our most sincere gratitude to the international advisory board, scientific committee, steering committee, organizing committee, and everybody taking parts in the success of the conference. We hope to see you in the 4th AASEC 2019.

The Editors

Dr. Ade Gafar Abdullah

Dr. Eng. Asep Bayu Dani Nandiyanto

LIST OF COMMITTEE

Conference Chair:

Dr. Ade Gafar Abdullah, M.Si.

Co- Conference Chair:

Ari Arifin Danuwijaya, M.Ed.

Advisory Boards:

Prof. Dr. Wahyu Widada, Universitas Bengkulu
Prof. Dr. Muhammad Ali Ramdhani, M.T., UIN Sunan Gunung Djati Bandung
Dr. Hadi Kuncoro, M. Farm., Apt., Universitas Mulawarman
Dr. Astri Rinanti, MT., Universitas Trisakti
Dr. Hilmi Aulawi, M.T., Sekolah Tinggi Teknologi Garut
Dr. Juniastel Rajagukguk, M.Si., Universitas Negeri Medan
Dr. Ir. Herman S., MBA., Universitas Komputer Indonesia
Dr. Endarto Y Wardhono, Universitas Sultan Ageng Tirtayasa, Banten
Dr. Niken Subekti, MSi., Universitas Negeri Semarang
Dr. Sudi Dul Aji., Universitas Kanjuruhan Malang
Dr. July Hidayat, M.Sn., Universitas Pelita Harapan
Dr. Jarman Arroisi, M.A., Universitas Darussalam Gontor Ponorogo Jatim
Dr. Ir. Suharsono., UPN Veteran Yogyakarta
Dr. Setia Budi, M.Sc., Universitas Negeri Jakarta
Dr. Ade Yeti Nuryantini, S.Pd., M.Pd., M.Si., UIN Sunan Gunung Djati Bandung
Dr. Bebeh Wahid Nuryadin., UIN Sunan Gunung Djati Bandung
Dr. Melati Ferianita Fachrul, MS., Universitas Trisakti
Dr.rer.nat. I Gusti Ngurah Agung Suryaputra, S.T., M.Sc., Universitas Pendidikan Ganesha
Daniel Sutopo Pamungkas, PhD., Politeknik Negeri Batam
Cynthia Wuisang, ST, MUrbHabMgt., PhD., Universitas Sam Ratulangi
Ir. Isri Ronald Mangangka, M.Eng., Ph.D., Universitas Sam Ratulangi

Scientific Committee

Prof. Dr. Asep Kadarohman, Universitas Pendidikan Indonesia, Indonesia
Prof. Dr. Didi Sukyadi, M. A., Universitas Pendidikan Indonesia, Indonesia
Prof. Dr. Anna Permanasari, Universitas Pendidikan Indonesia, Indonesia
Prof. Dr. Sumarto, Universitas Pendidikan Indonesia, Indonesia
Prof. Dr. M. Syaom Barliana, Universitas Pendidikan Indonesia, Indonesia
Prof. Dr. Ratih Hurriyati, Universitas Pendidikan Indonesia, Indonesia
Dr. Ir. Taufiq Saidi, M. Eng., Universitas Syiah Kuala, Indonesia
Dr. Erfan Handoko, M.Si., Universitas Negeri Jakarta, Indonesia
Dr. Hilmi Aulawi, MT., Sekolah Tinggi Teknologi Garut, Indonesia
Dr. Astri Rinanti, MT., Universitas Trisakti, Indonesia
Dr. Prantasi H. Tjahjanti, Universitas Muhammadiyah Sidoarjo, Indonesia
Dr. Rositayanti Hadisoebroto, ST., MT., Universitas Trisakti, Indonesia
Erfan Rohadi, ST., M.Eng., PhD. b., Politeknik Negeri Malang, Indonesia
Indrazno Siradjuddin, ST, MT, PhD., Politeknik Negeri Malang, Indonesia
Irwan Alnarus Kautsar, Ph.D., Universitas Muhammadiyah Sidoarjo, Indonesia

Muhammad Nur Hudha, M.Pd., Universitas Kanjuruhan Malang, Indonesia

Organizing Committee

Dr. Eng. Asep Bayu Dani Nandiyanto, M.Eng. – Universitas Pendidikan Indonesia

Dr. Isma Widiaty, M.Pd. – Universitas Pendidikan Indonesia

Tutin Aryanti, Ph.D – Universitas Pendidikan Indonesia

Cep Ubad Abdullah, M.Pd. – Universitas Pendidikan Indonesia

Agus Juhana, S.Pd – Universitas Pendidikan Indonesia

Diky Zakaria, S.Pd – Universitas Pendidikan Indonesia

Nia Amelia, S.Pd – Universitas Pendidikan Indonesia

Wildan Arrasyid, S.Pd – Universitas Pendidikan Indonesia

CONFERENCE PHOTOGRAPH











PAPER • OPEN ACCESS

Peer review statement

To cite this article: 2018 *IOP Conf. Ser.: Mater. Sci. Eng.* **434** 011002

View the [article online](#) for updates and enhancements.

Peer review statement

All papers published in this volume of *IOP Conference Series: Materials Science and Engineering* have been peer reviewed through processes administered by the proceedings Editors. Reviews were conducted by expert referees to the professional and scientific standards expected of a proceedings journal published by IOP Publishing.



Piracy Threat – Important update to keep your details safe and secure. [Click here for further information.](#)

Table of contents

Volume 434

2018

[◀ Previous issue](#) [Next issue ▶](#)

3rd Annual Applied Science and Engineering Conference (AASEC 2018) 18 April 2018, Bandung, Indonesia

Open all abstracts

Preface

OPEN ACCESS 011001

3rd Annual Applied Science and Engineering Conference (AASEC 2018)

[+ Open abstract](#) [View article](#) [PDF](#)

OPEN ACCESS 011002

Peer review statement

[+ Open abstract](#) [View article](#) [PDF](#)

Papers

OPEN ACCESS 012001

Historical aspect of mathematics on Indonesian mathematics textbook

R Ekawati, S Fiangga and T Y E Siswono

[+ Open abstract](#) [View article](#) [PDF](#)

OPEN ACCESS 012002

Multimedia learning to overcome anxiety and mathematics difficulty

H M D Soewardini, M Meilantifa and H Sukrisno

[+ Open abstract](#) [View article](#) [PDF](#)

OPEN ACCESS 012003

Maple app: specifies the vector derivative

R L Ariany, T T Widiastuti A, E Farlina, T K Rachmawati and J Juariah

[+ Open abstract](#) [View article](#) [PDF](#)

OPEN ACCESS 012004

Mathematics teaching Aids to improve the students abstraction on Geometry in Civil Engineering of State Polytechnic Malang

M L Dewi, A R Hakim, A Setiawan, S Adhisuwignjo and E Rohadi

[+ Open abstract](#) [View article](#) [PDF](#)

OPEN ACCESS 012005

Single population modelling on predicting global carbon dioxide concentration

A Rukmananda and C Barenz

[+ Open abstract](#) [View article](#) [PDF](#)

This site uses cookies. By continuing to use this site you agree to our use of cookies. To find out more, see our [Privacy and Cookies policy](#).



-
- OPEN ACCESS** 012006
The effectiveness of vaccine in the outbreak of diphtheria: mathematical model and simulation
F Ilahi and A Widiana
[+ Open abstract](#) [View article](#) [PDF](#)
-
- OPEN ACCESS** 012007
Application of Markov Chain to stock trend: A study of PT HM Sampoerna, Tbk.
A Fitriyanto and T E Lestari
[+ Open abstract](#) [View article](#) [PDF](#)
-
- OPEN ACCESS** 012008
Improving mathematical understanding ability student through study of mobile learning mathematics base on the Android
A Jihad, W Susilawati and N Sobarningsih
[+ Open abstract](#) [View article](#) [PDF](#)
-
- OPEN ACCESS** 012009
The effect of infrastructure and human resources on the higher education services output
E R Wulan, A Muhyiddin, H Ainissyifa and M A Ramdhani
[+ Open abstract](#) [View article](#) [PDF](#)
-
- OPEN ACCESS** 012010
Ordinary differential equations: students' difficulty in solve the algorithm of the initial value problem with the integrating factor method
E Farlina, T K Rachmawati, R L Ariany, T T Widiastuti A and N Sobarningsih
[+ Open abstract](#) [View article](#) [PDF](#)
-
- OPEN ACCESS** 012011
The development of Adobe Flash-based interactive multimedia to enhance students' mathematical communication skills
W Susilawati, I Maryono and S Maimunah
[+ Open abstract](#) [View article](#) [PDF](#)
-
- OPEN ACCESS** 012012
Radiological safety analysis of the SAMOP reactor experimental facility
S Syarip, E Supriyatni and R Ridhani
[+ Open abstract](#) [View article](#) [PDF](#)
-
- OPEN ACCESS** 012013
Economic dispatch and operating cost optimization for thermal power in 500 KV system using genetic algorithm (GA)
N M Azkiya, A G Abdullah and H Hasbullah
[+ Open abstract](#) [View article](#) [PDF](#)
-
- OPEN ACCESS** 012014
Moment of inertia: development of rotational dynamics KIT for physics students
D Mulhayatiah, H Y Suhendi, R Zakwandi, Y Dirgantara and M A Ramdani
[+ Open abstract](#) [View article](#) [PDF](#)
-
- OPEN ACCESS** 012015
Physics concept on flood mitigation in West Java
This site uses cookies. By continuing to use this site you agree to our use of cookies. To find out more, see our Privacy and Cookies policy.
C Rochman, R N Yulianti, D Nasrudin and A Malik



[+ Open abstract](#) [View article](#) [PDF](#)

OPEN ACCESS 012016

High school physics teacher's competences in designing physics lesson plan for improving student's energy literacy

S Sukendar and A Setiawan

[+ Open abstract](#) [View article](#) [PDF](#)

OPEN ACCESS 012017

Measuring the coefficient of emissivity using thermal radiation equipment SNR V-1.4 SL

A Malik, R Zakwandi, S Nurfalah, N Nurhayati, C Rochman and D Nasrudin

[+ Open abstract](#) [View article](#) [PDF](#)

OPEN ACCESS 012018

Physics on soil erosion in Batang Sinamar, West Sumatra

D Nasrudin, R Zakwandi, S Putra, C Rochman and A Malik

[+ Open abstract](#) [View article](#) [PDF](#)

OPEN ACCESS 012019

Chemical physics in the process of making handicraft Pandanus tectorius and its local wisdom

D Nasrudin, C Rochman, E K Yuningsih, I Helsy and A Hasanah

[+ Open abstract](#) [View article](#) [PDF](#)

OPEN ACCESS 012020

Effects of ozone-washing in a series of ozonation methods for inhibition of total microbial growth in some varieties of chili (*Capsicum annum L.*)

E Sasmita, A I Susan, E Yulianto, M Restiwijaya, A W Kinandana, F Arianto and M Nur

[+ Open abstract](#) [View article](#) [PDF](#)

OPEN ACCESS 012021

Ozone immersion treatment to increase the shelf life of Tuna fish, milk fish, and shrimp in a cold storage system

Y Yuliani, M Puspita, M Nur, T W Agustini, E Yulianto, A I Susan, I Zahar and B Suraya

[+ Open abstract](#) [View article](#) [PDF](#)

OPEN ACCESS 012022

Determination of growth and production responses of shallot (*Allium cepa L.*) due to corona plasma irradiation

I Puspitasari, E Prihastanti, D T Sugianto, A I Susan, E Yulianto, F Arianto, E Sasmita and M Nur

[+ Open abstract](#) [View article](#) [PDF](#)

OPEN ACCESS 012023

The simulation of a symmetric quantum key distribution

M Delina, B H Iswanto, H Permana and S Muhasyah

[+ Open abstract](#) [View article](#) [PDF](#)

OPEN ACCESS 012024

Comparison between corona and dielectric barrier discharges plasma using of pin to single and dual ring electrodes configuration

S Sumariyah, I Hanafi, Z Muchisin, F Arianto and M Nur

[+ Open abstract](#) [View article](#) [PDF](#)

OPEN ACCESS 012025
This site uses cookies. By continuing to use this site you agree to our use of cookies. To find out more, see our Privacy and Cookies policy. 

M Nur, T Suhartatin, Z Muchisin and J P Wibawa

[+ Open abstract](#)
[View article](#)
[PDF](#)

OPEN ACCESS

012026

The computation parameters optimizations for electronic structure calculation of LiPb_3 perovskite by the density functional theory method

P Pitriana, T D K Wungu, H Herman and R Hidayat

[+ Open abstract](#)
[View article](#)
[PDF](#)

OPEN ACCESS

012027

Preliminary studies of $\text{Mn}_{(x)}\text{Zn}_{(2-x)}\text{FeO}_4$ ($x = 0$ dan 0.1) thick film semiconductors as an ethanol gas sensor

H Aliah, D G Syarif, R N Iman, W Darmalaksana, A Setiawan and A Sawitri

[+ Open abstract](#)
[View article](#)
[PDF](#)

OPEN ACCESS

012028

Influence of learning model and learning motivation to learning outcome of micro hydro power plant

R Rusmono, S Sulardi and S Suyitno

[+ Open abstract](#)
[View article](#)
[PDF](#)

OPEN ACCESS

012029

Prevalence faltfoot in primary school

N P D Witari, P N Cahyawati and A Lestarin

[+ Open abstract](#)
[View article](#)
[PDF](#)

OPEN ACCESS

012030

Application of adaline artificial neural network for classroom determination in elementary school

A N Handayani, A D Aindra, D F Wahyulis, S Pathmantara and R A Asmara

[+ Open abstract](#)
[View article](#)
[PDF](#)

OPEN ACCESS

012031

MURRDERR strategy in developing mathematical investigation thinking skill of elementary school pre-service teacher

M Maulana, N Hanifah, A N Aeni, J Julia and A A Syahid

[+ Open abstract](#)
[View article](#)
[PDF](#)

OPEN ACCESS

012032

K-means method with linear search algorithm to reduce Means Square Error (MSE) within data clustering

S Sriadhi, S Gultom, M Martiano, R Rahim and D Abdullah

[+ Open abstract](#)
[View article](#)
[PDF](#)

OPEN ACCESS

012033

The Implementation of Breadth First Search in Determining of Waris

O T Kurahman, Y A Gerhana, F A Perdana, U Syarifuddin, S Khosyi'ah, N Lukman and I Taufik

[+ Open abstract](#)
[View article](#)
[PDF](#)

OPEN ACCESS

012034

Java character recognition using Hopfield network

W Widodo, R A Priambodo and B P Adhi

[+ Open abstract](#)
[View article](#)
[PDF](#)

Association rule algorithm with FP growth for book search

012035

Open Access cookies. By continuing to use this site you agree to our use of cookies. To find out more, see our Privacy and Cookies policy.

T Andi and E Utami

[+ Open abstract](#) [View article](#) [PDF](#)

OPEN ACCESS

012036

Android-based monitoring applications of students' learning outcomes

P Sulistyowati, L Setyaningrum, F N Kumala and M N Hudha

[+ Open abstract](#) [View article](#) [PDF](#)

OPEN ACCESS

012037

The smart method to support a decision based on multi attributes identification

Y S Dwanoko, F Y Habibi, H L Purwanto, I K Swastika and M N Hudha

[+ Open abstract](#) [View article](#) [PDF](#)

OPEN ACCESS

012038

Analysis of Artificial Bee Colony algorithm for optimizing lecture schedule based on willingness of teaching submission

C N Alam, D Maylawati, M R Al-fayumi and M A Ramdhani

[+ Open abstract](#) [View article](#) [PDF](#)

OPEN ACCESS

012039

The prediction of scholarship recipients in higher education using k-Nearest neighbor algorithm

D Kurniadi, E Abdurachman, H L H S Warnars and W Suparta

[+ Open abstract](#) [View article](#) [PDF](#)

OPEN ACCESS

012040

Profession recommended system for higher education students using Bayesian method

V R Palilingan and J R Batmetan

[+ Open abstract](#) [View article](#) [PDF](#)

OPEN ACCESS

012041

Expert system for determining the type of cats and how to care them

H Mustafidah, R Amin and V A N Fatimah

[+ Open abstract](#) [View article](#) [PDF](#)

OPEN ACCESS

012042

The concept of sequential pattern mining for text

D S Maylawati, H Aulawi and M A Ramdhani

[+ Open abstract](#) [View article](#) [PDF](#)

OPEN ACCESS

012043

The concept of frequent itemset mining for text

D S Maylawati

[+ Open abstract](#) [View article](#) [PDF](#)

OPEN ACCESS

012044

Computer speech recognition to text for recite Holy Quran

Y A Gerhana, A R Atmadja, D S Maylawati, A Rahman, K Nufus, H Qodim, Busr and M A Ramdhani

[+ Open abstract](#) [View article](#) [PDF](#)

OPEN ACCESS

012045

This site uses cookies. By continuing to use this site you agree to our use of cookies. To find out more, see our Privacy and Cookies policy.



D Tresnawati

[+ Open abstract](#)
[View article](#)
[PDF](#)
OPEN ACCESS

012046

A hybrid cryptosystem based on zig-zag algorithm and Rivest Shamir Adleman (RSA) algorithm

D Rachmawati, M A Budiman and R S Lubis

[+ Open abstract](#)
[View article](#)
[PDF](#)
OPEN ACCESS

012047

Comparison of Naive Bayes and K-Nearest Neighbor methods to predict divorce issues

M Irfan, W Uriawan, O T Kurahman, M A Ramdhani and I A Dahlia

[+ Open abstract](#)
[View article](#)
[PDF](#)
OPEN ACCESS

012048

The comparison of decision tree and k-NN to analyze fertility using 2 different filters

N Rochmawati, H B Hidayati, Y Yamasari, I G P Asto and L Rakhmawati

[+ Open abstract](#)
[View article](#)
[PDF](#)
OPEN ACCESS

012049

Analysis of determinant factors of e-Government implementation

M A Ramdhani, H Aulawi and D Gojali

[+ Open abstract](#)
[View article](#)
[PDF](#)
OPEN ACCESS

012050

A preliminary investigation of information system using Ishikawa diagram and sectoral statistics

R Cahyana

[+ Open abstract](#)
[View article](#)
[PDF](#)
OPEN ACCESS

012051

Migration planning for e-Government

L Fitriani

[+ Open abstract](#)
[View article](#)
[PDF](#)
OPEN ACCESS

012052

Content website of small and medium enterprises

E Satria

[+ Open abstract](#)
[View article](#)
[PDF](#)
OPEN ACCESS

012053

Script knowledge representation in game designing for instructional media

D D S Fatimah

[+ Open abstract](#)
[View article](#)
[PDF](#)
OPEN ACCESS

012054

Impact of private editor article citations to journal citation: a case of Indonesian accredited "A" journals

D Muriyatmoko and H Setyaningrum

[+ Open abstract](#)
[View article](#)
[PDF](#)
OPEN ACCESS

012055

Song creation by using computer music notation

This site uses cookies. By continuing to use this site you agree to our use of cookies. To find out more, see our Privacy and Cookies policy.

J Julia, P D Iswara and T Supriyadi



[+ Open abstract](#) [View article](#) [PDF](#)

OPEN ACCESS 012066

Oil palm fresh fruit bunch ripeness classification using back propagation and learning vector quantization

F Fahmi, H Palti M, S Emerson P and S Suherman

[+ Open abstract](#) [View article](#) [PDF](#)

OPEN ACCESS 012067

Mindfulness in high-reliability health care: a glance into Bali international medical centre

M U Rimayanti and M I Wijaya

[+ Open abstract](#) [View article](#) [PDF](#)

OPEN ACCESS 012068

Simulation study of singular spectrum analysis from time series data with outlier

G Darmawan, D Rosadi and B N Ruchjana

[+ Open abstract](#) [View article](#) [PDF](#)

OPEN ACCESS 012069

A survey on language learning through song-based information technology

P D Iswara, J Julia and T Supriyadi

[+ Open abstract](#) [View article](#) [PDF](#)

OPEN ACCESS 012070

Classification of Dengue Haemorrhagic Fever (DHF) using SVM, naive bayes and random forest

R Arafiyah, F Hermin, I R Kartika, A Alimuddin and I Saraswati

[+ Open abstract](#) [View article](#) [PDF](#)

OPEN ACCESS 012071

Preparation of chitosan composite film using activated carbon from oil palm empty fruit bunch for Cd²⁺ removal from water

Rahmi

[+ Open abstract](#) [View article](#) [PDF](#)

OPEN ACCESS 012072

Classification of pork and beef meat images using extraction of color and texture feature by Grey Level Co-Occurrence Matrix method

R A Asmara, R Romario, K S Batubulan, E Rohadi, I Siradjuddin, F Ronilaya, R Ariyanto, C Rahmad and F Rahutomo

[+ Open abstract](#) [View article](#) [PDF](#)

OPEN ACCESS 012073

Instructional development of tie dye creation for elderly using a video tutorial

A Oetopo, D N Musnir and Y Yufiarti

[+ Open abstract](#) [View article](#) [PDF](#)

OPEN ACCESS 012074

Analysis of magnesiums mechanical properties through tensile test

U Sumirat, A Djohar, I Kuntadi and S Supriatno

[+ Open abstract](#) [View article](#) [PDF](#)

OPEN ACCESS 012075

Formation of electrodeposited Ni-TiAlN/Si₃N₄ composite coating: effect of Si₃N₄ concentration

P Djani, I Sugihartono, W Indrasari, Y Ermadiana, D Syafindra, A Fikry and Y Oktaviani

This site uses cookies. By continuing to use this site you agree to our use of cookies. To find out more, see our Privacy and Cookies



[+ Open abstract](#) [View article](#) [PDF](#)

OPEN ACCESS

012076

Investigating the effect of eggshell burning temperature on the mechanical properties of artificial teeth

A Sabir, H Abbas, Y Aminy and S Akmal

[+ Open abstract](#) [View article](#) [PDF](#)

OPEN ACCESS

012077

Crystal structure analyses of ZnO nanoparticles growth by simple wet chemical method

I Sugihartono, D Dianisya and I Isnaeni

[+ Open abstract](#) [View article](#) [PDF](#)

OPEN ACCESS

012078

Isolation of cellulose from salacca midrib fibers by chemical treatments

V Yudha, H S B Rochardjo, J Jamasri, R Widyorini, F Yudhanto and S Darmanto

[+ Open abstract](#) [View article](#) [PDF](#)

OPEN ACCESS

012079

Preparation of reduced Graphene Oxide (rGO) assisted by microwave irradiation and hydrothermal for reduction methods

S Setiadji, B W Nuryadin, H Ramadhan, C D D Sundari, T Sudiarti, A Supriadin and A L Ivansyah

[+ Open abstract](#) [View article](#) [PDF](#)

OPEN ACCESS

012080

The variations ITO concentration for observed properties of conductivity of polymer liquid crystal of cholesteryl acrylate-indium tin oxide

A Afrizal, A Rahman, Y Ai and E Handoko

[+ Open abstract](#) [View article](#) [PDF](#)

OPEN ACCESS

012081

Electromagnetic wave absorbing properties of husk silica-based SiO₂/Fe₃O₄/UPR composite

Y Yusmaniar, W Ari A, D K Hutomo and E Handoko

[+ Open abstract](#) [View article](#) [PDF](#)

OPEN ACCESS

012082

Development of paper indicator from sambang colok (*Aerva sanguinolenta*) plant extract

S Sopiah, S Sari and N Windayani

[+ Open abstract](#) [View article](#) [PDF](#)

OPEN ACCESS

012083

Challenge sodium lignosulfonate surfactants synthesized from bagasse as an injection fluid based on hydrophilic-lipophilic balance

R Setiati, S Siregar, T Marhaendrajana and D Wahyuningrum

[+ Open abstract](#) [View article](#) [PDF](#)

OPEN ACCESS

012084

Synthesis of zeolite ZSM-11 using bamboo leaf as silica source

S Setiadji, I S Nurazizah, C D D Sundari, W Darmalaksana, D F Nurbaeti, I Novianti, T B N Azizah, D Abdurrahman and A L Ivansyah

[+ Open abstract](#) [View article](#) [PDF](#)

OPEN ACCESS

012085

The effect of kefir whey addition on soap characteristics

[+ Open abstract](#) [View article](#) [PDF](#)

policy.



I Helys, I F Faozah H A, N Windayani and D Nasrudin

[+ Open abstract](#) [View article](#) [PDF](#)

OPEN ACCESS

012086

Analysis of critical thinking skills in chemistry learning by using mobile learning for level x

U Cahyana, E Fitriani, R Rianti and S Fauziyah

[+ Open abstract](#) [View article](#) [PDF](#)

OPEN ACCESS

012087

Corrosion inhibition using lignin of sugarcane bagasse

P P Rahayu, C D D Sundari and I Farida

[+ Open abstract](#) [View article](#) [PDF](#)

OPEN ACCESS

012088

An approach to determine the concentration of coloured solution using android smartphones

F S Irwansyah, I Susilawati, I Fitriyati, I Farida, B W Nuryadin and M A Ramdhani

[+ Open abstract](#) [View article](#) [PDF](#)

OPEN ACCESS

012089

The development of buffer solution material through flipped classroom model

C Z Subarkah, U Supiandi and S Sari

[+ Open abstract](#) [View article](#) [PDF](#)

OPEN ACCESS

012090

Characterization of sunscreen cream containing benzophenone-3,3',4,4'-tetracarboxylate dianhydride

A D Djalil, T Ambarwati and E Genatrika

[+ Open abstract](#) [View article](#) [PDF](#)

OPEN ACCESS

012091

Application of thin layer chromatography-densitometry method for analysis of metoprolol in plasma and urine

P Utami, L Alfiah and D Estika

[+ Open abstract](#) [View article](#) [PDF](#)

OPEN ACCESS

012092

Preparation of chitosan composite film using activated carbon from oil palm empty fruit bunch for Cd²⁺ removal from water

Rahmi

[+ Open abstract](#) [View article](#) [PDF](#)

OPEN ACCESS

012093

Development of generic science skills on determination of mineral chloride levels in packed drink using inquiry guided laboratory

S Yulia, S C Zenab and H Dinar

[+ Open abstract](#) [View article](#) [PDF](#)

OPEN ACCESS

012094

Immunogenicity evaluation of recombinant fim-c salmonella typhi protein as typhoid vaccine candidate on wistar rat

M Nurjayadi, I R Kartika, F Kurniadewi, N Nurasih, D Ariastuti, A Sulfianti, K Agustini and W M Wardoyo

[+ Open abstract](#) [View article](#) [PDF](#)

This site uses cookies. By continuing to use this site you agree to our use of cookies. To find out more, see our [Privacy and Cookies](#)

OPEN ACCESS

012095

Development of Android-Based Mobile learning media on Atomic Structure and Periodic Table

U Cahyana, M Paristiowati and S Fauziyah

[+ Open abstract](#)
[View article](#)
[PDF](#)

OPEN ACCESS

012096

Extraction of natural dye powder from morinda *citrifolia* and its application as antibacterial dyes for cotton fabrics

A Rahman, M Muktiningsih, F L Andika, I Kartini and R Slamet

[+ Open abstract](#)
[View article](#)
[PDF](#)

OPEN ACCESS

012097

Evaluation of primer detection capabilities of fimC Salmonella typhi using real time PCR for rapid detection of bacteria causes of food poisoning

M Nurjayadi, N Islami, Y P Pertiwi, V Saamia and I M Wirana

[+ Open abstract](#)
[View article](#)
[PDF](#)

OPEN ACCESS

012098

The effectiveness of flipped classroom in high school Chemistry Education

H Syakdiyah, B Wibawa and H Muchtar

[+ Open abstract](#)
[View article](#)
[PDF](#)

OPEN ACCESS

012099

The Growth of FeCoNi nanoparticles Electrodeposited from CTAB-assisted Sulfate Electrolyte

S Budi, A Afrizal, E Handoko and R Fahdiran

[+ Open abstract](#)
[View article](#)
[PDF](#)

OPEN ACCESS

012100

Effect of various lighting colours treatment at growth and flowering of *Chrysanthemum Morifolium*

L Kamelia, L Chaidir, A Ainas, S Nurdianawati and I F Fauzi

[+ Open abstract](#)
[View article](#)
[PDF](#)

OPEN ACCESS

012101

Learning development model biological material "flowers wijaya kusuma (*Epiphyllum anguliger*)" by using augmented reality media to facilitate independent learning students

S Wilujeng, D Chamidah and E Wahyuningtyas

[+ Open abstract](#)
[View article](#)
[PDF](#)

OPEN ACCESS

012102

Effect of different extender on the quality of sexing sperm before freezing in limousin cattle

E D Kusumawati, S Rahadi, N Isnaini, S Wahjuningsih, A G Abdullah, R Agustina and T Susilawati

[+ Open abstract](#)
[View article](#)
[PDF](#)

OPEN ACCESS

012103

Molecular species of *Diaphanes* sp from Nusa Kambangan Island as a source of luciferase molecular marker on cancer diagnostic

R Puspitaningrum, Y Rustam, T Handayani, N Mudjihartini and G D Junihadi

[+ Open abstract](#)
[View article](#)
[PDF](#)

OPEN ACCESS

012104

Polyisoprenoids profile and composition from selected plant Sapotaceae family

M Basyuni and R Wati

[+ Open abstract](#)
[View article](#)
[PDF](#)

This site uses cookies. By continuing to use this site you agree to our use of cookies. To find out more, see our [Privacy and Cookies policy](#).





















-
- OPEN ACCESS** 012105
Isolation and characterization of aflatoxigenic *Aspergillus* spp. from maize of livestock feed from Bogor
D Sukmawati, A Setyaningsih, T Handayani K, S Rahayu, Y Rustam, M Moersilah, P Wahyudi and S N A Husna
[+ Open abstract](#) [View article](#) [PDF](#)
-
- OPEN ACCESS** 012106
Palatability level of cajuput leaf waste by addition of concentrate as feed substitution for sheep
A Widiana, D F Nur R, R M Hasby and I Hernaman
[+ Open abstract](#) [View article](#) [PDF](#)
-
- OPEN ACCESS** 012107
Minimum viable population estimation of Timor Deer (*Rusa timorensis*) base on demographic parameters
A Yuliawati, T Kurniati, Y Santosa and A M Thohari
[+ Open abstract](#) [View article](#) [PDF](#)
-
- OPEN ACCESS** 012108
Tannin as a feed additive for mitigating enteric methane emission from livestock: meta-analysis from RUSITEC experiments
A Jayanegara, M Ridla, E B Laconi and N Nahrowi
[+ Open abstract](#) [View article](#) [PDF](#)
-
- OPEN ACCESS** 012109
Feeding rate of subterranean termites in wood treated with smoke wood and borax
Ni Subekti, F Fibriana and P Widiyaningrum
[+ Open abstract](#) [View article](#) [PDF](#)
-
- OPEN ACCESS** 012110
Growth and yield of chili on post-mine sandpits treated by Arbuscular Micorhizal fungi and organic matter
C Hidayat, Y Setiati and P Gustini
[+ Open abstract](#) [View article](#) [PDF](#)
-
- OPEN ACCESS** 012111
Growth and yield of hydroponic watermelon with straw compost substrate and gibberelins (GA3) application
B Frasetya, N Nurfatha, K Harisman and M Subandi
[+ Open abstract](#) [View article](#) [PDF](#)
-
- OPEN ACCESS** 012112
Molecular analysis of candida albicans Secreted Aspartyl Proteinase 3 (SAP3) Indonesian isolate
A T Permata, A A Prasetyo and S Haryati
[+ Open abstract](#) [View article](#) [PDF](#)
-
- OPEN ACCESS** 012113
Construction and molecular analysis of hepatitis B virus core 1-144 + human immunodeficiency virus Gag recombination from Indonesian isolates
A A Prasetyo, A T Permata and M Marwoto
[+ Open abstract](#) [View article](#) [PDF](#)
-
- OPEN ACCESS** 012114
Interleukin-6-174 promoter polymorphism and susceptibility to hepatitis B virus infection in Javanese individuals
A A Prasetyo, M Marwoto and W Monica
[+ Open abstract](#) [View article](#) [PDF](#)
-
- [This site uses cookies. By continuing to use this site you agree to our use of cookies. To find out more, see our Privacy and Cookies policy.](#)



-
- OPEN ACCESS** 012115
Cloning and molecular analysis of *Toxoplasma gondii* Surface Antigen 2 (SAG2) gene cloned from *Toxoplasma gondii* DNA isolated from Javanese acute toxoplasmosis
W Monica, A A Prasetyo and S Haryati
[+ Open abstract](#) [View article](#) [PDF](#)
-
- OPEN ACCESS** 012116
The comparison of cocoa growth in different vegetation compositions
E Prihastanti and Y Nurchayati
[+ Open abstract](#) [View article](#) [PDF](#)
-
- OPEN ACCESS** 012117
Effect of combination of NPK and nano silica on the levels of β -carotene and nutritional value of corn (*Zea mays* L.)
E Prihastanti, A Subagyo and N Ngadiwiyan
[+ Open abstract](#) [View article](#) [PDF](#)
-
- OPEN ACCESS** 012118
In vitro gas production of legume *Bauhinia purpurea*, *Cassia alata* and *Macroptilium atropurpureum*
A Ikhwanti, I G Permana, Y Retnani, A A Samsudin and A Jayanegara
[+ Open abstract](#) [View article](#) [PDF](#)
-
- OPEN ACCESS** 012119
Effectiveness of tofu waste for decreasing chlorogenic acid of robusta coffee (coffee robusta Lindl.Ex De Will)
A R Sulistyningtyas, E Prihastanti and E D Hastuti
[+ Open abstract](#) [View article](#) [PDF](#)
-
- OPEN ACCESS** 012120
Adaptation of acid-tolerant *Leucaena leucocephala* cv Tarramba Calluses after gamma irradiation on regenerative media
M F Latief, P D M H Karti and I Prihantoro
[+ Open abstract](#) [View article](#) [PDF](#)
-
- OPEN ACCESS** 012121
Effect of Zeolite size measures and urea fertilizers to growth and yield endive Plant (*Cichorium endivia* L.)
D Lestia, A Taofik and H Aliah
[+ Open abstract](#) [View article](#) [PDF](#)
-
- OPEN ACCESS** 012122
Role of nitrogen and phosphate dynamics to increase plant survival grown on oil contaminated soil
Y S Rahayu, Y Yuliani, G Trimulyono, E Ratnasari and S K Dewi
[+ Open abstract](#) [View article](#) [PDF](#)
-
- OPEN ACCESS** 012123
Identification of bacteria on Cockroach feet from Hospital area in Palu city and test of sensitivity to antibiotic
P M A Astiti, M Bialangi and I N Kundera
[+ Open abstract](#) [View article](#) [PDF](#)
-
- OPEN ACCESS** 012124
Distribution Of Brittle Star (Ophiuroidea) on Rancabuaya Coastal Areas, Garut, West Java
E Paujjah, I Kinasih, P Hawa, A Widiana, T Kurniati and T Cahyanto
This site uses cookies. By continuing to use this site you agree to our use of cookies. To find out more, see our Privacy and Cookies
[+ Open abstract](#) [View article](#) [PDF](#)



-
- OPEN ACCESS** 012125
 Screening the capabilities of Indonesian indigenous mold in producing cellulase enzyme
 D Sukmawati, D Dellanerra and A Risandi
 + Open abstract  View article  PDF
-
- OPEN ACCESS** 012126
 Histomorphology of testis in male mice (*Mus musculus albinus*) post given the aqueous seed extract of neem (*Azadirachta indica* A. Juss)
 E Lisanti, D Sajuthi, M Agil, R I Arifiantini and A Winarto
 + Open abstract  View article  PDF
-
- OPEN ACCESS** 012127
 Students' view of environmental awareness and energy conservation activities in campus
 L Rosdiana, Y S Rahayu, H Subekti and D A P Sari
 + Open abstract  View article  PDF
-
- OPEN ACCESS** 012128
 The effect of use of tofu dregs fermented on feed efficiency and growth of African cat fish (*Clarias gariepinus*)
 S Suwarsito and C Purbomartono
 + Open abstract  View article  PDF
-
- OPEN ACCESS** 012129
 Genetic diversity of cinnamon plants (*Cinnamomum burmanii* BL.) at various altitude based on morphological character
 L Lizawati, A Riduan, N Neliyati, Y Alia and D Antony
 + Open abstract  View article  PDF
-
- OPEN ACCESS** 012130
 Bio-psychology review on Low Level Laser Therapy management to overcome the condition of elephantiasis in chronic filariasis
 A Sulianti, R Agoes, D Hilmanto and T S Adikara
 + Open abstract  View article  PDF
-
- OPEN ACCESS** 012131
 Habits of happy brain to develop the culture of Quran literacy
 A Sulianti, E Djuliawati and S Sulasman
 + Open abstract  View article  PDF
-
- OPEN ACCESS** 012132
 The development of BOT API social media Telegram about plant hormones using Black Box Testing
 Y S Rahayu, S C Wibawa, Y Yuliani, E Ratnasari and S Kusumadewi
 + Open abstract  View article  PDF
-
- OPEN ACCESS** 012133
 Bio-Psychology of Lip-sync method for shaping the character of Quran memorized ronunciation
 A Sulianti, T Tarsono, T Augustiya and W Darmalaksana
 + Open abstract  View article  PDF
-
- OPEN ACCESS** 012134
 Growth responses of alfalfa (*Medicago sativa* (L.) as affected by gamma irradiation
 M Natsir, I Prnantoro and P D M H Karti



[+ Open abstract](#) [View article](#) [PDF](#)

OPEN ACCESS 012135

Prevalence of intestinal helminth parasites in wild and soft-release Bornean Orangutan (*Pongo pygmaeus*) in Lamandau Wildlife reserve, Central Kalimantan

M Zulfikri, Y Ridwan and U Cahyaningsih

[+ Open abstract](#) [View article](#) [PDF](#)

OPEN ACCESS 012136

How to inhibit the habit of masturbation in cybersex adolescents, from bio-psychological approach?

A Sulianti, I Sunardi, W Hernawan, W P Anggraeni, Z R Adawiyah, F N F Ramadhan and I Fauzi

[+ Open abstract](#) [View article](#) [PDF](#)

OPEN ACCESS 012137

Can emotional intelligence restrain excess celebrity worship in bio-psychological perspective?

A Sulianti, F S Lubis, F Az-Zahra and A Hambali

[+ Open abstract](#) [View article](#) [PDF](#)

OPEN ACCESS 012138

PCA (Principal Component Analysis) application to differentiate hybrid and pure black-winged myna (*Acridotheres melanopterus*)

R E Vernia, A Tritto, A Abinawanto, N Winarni, A Mayasari, A Sedayu and A Bowolaksono

[+ Open abstract](#) [View article](#) [PDF](#)

OPEN ACCESS 012139

Differentiating hybrid and juvenile of black-winged myna (*Acridotheres melanopterus*) by using morphometric data

R E Vernia, A Tritto, A Abinawanto, N Winarni, A Mayasari, A Sedayu and A Bowolaksono

[+ Open abstract](#) [View article](#) [PDF](#)

OPEN ACCESS 012140

The postpartum anestrus period of lowland anoa (*Bubalus depressicornis*) in captivity

A Mayasari, A Suryawan, J E Halawane, J Kinho, R E Vernia, A Abinawanto, A Suryanda and A Bowolaksono

[+ Open abstract](#) [View article](#) [PDF](#)

OPEN ACCESS 012141

Pharmacokinetic aspect of *Carica papaya* leaf extract after oral administration

W H Nugrahaningsih, N Paramitha, L Lisdiana and Ely Rudyatmi

[+ Open abstract](#) [View article](#) [PDF](#)

OPEN ACCESS 012142

Correlation of Eosinofil and Basophil count with intensity of soil transmitted helminth infection among farmers in Bali

P I B Apsari, H Arwati and Y P Dachlan

[+ Open abstract](#) [View article](#) [PDF](#)

OPEN ACCESS 012143

Music therapy on sleep quality in elderly

A Lestarini and K S P Putra

[+ Open abstract](#) [View article](#) [PDF](#)

This site uses cookies. By continuing to use this site you agree to our use of cookies. To find out more, see our [Privacy and Cookies policy](#).

012143 

Titer of anti-HBs antibodies following a booster vaccination among medical students

K T Sumadewi, M J Rachmanu and D P C Udiyani

[+ Open abstract](#)
[View article](#)
[PDF](#)

OPEN ACCESS

012145

A case of imported *Plasmodium Falciparum* chloroquine and Sulfadoxine-Pyrimethamine sensitive in a Finland male presentation

N P D Witari, S Masyeni, N W Rusni, K T Sumadewi, A E Pratiwi and P B Asih

[+ Open abstract](#)
[View article](#)
[PDF](#)

OPEN ACCESS

012146

Upper and lower gastrointestinal endoscopic findings among patients visiting BRSUD Tabanan with various gastrointestinal symptoms: a three year retrospective study

D P Surawan, N W Widhidewi, P A Suryanditha and S Masyeni

[+ Open abstract](#)
[View article](#)
[PDF](#)

OPEN ACCESS

012147

Association between neutrophil to lymphocyte ratio on admission and grace mortality risk score among acute myocardial infarction patient at BRSUD Tabanan in 2017

P G E A Suyasa

[+ Open abstract](#)
[View article](#)
[PDF](#)

OPEN ACCESS

012148

The characteristics of waste product from the process of *pemindangan* in local village Bali

I G S Pandit

[+ Open abstract](#)
[View article](#)
[PDF](#)

OPEN ACCESS

012149

Correlation of enhancement Mean Platelet Volume (MPV) with severity of dengue infection

S R Dewi, U Sukorini and U S Intansari

[+ Open abstract](#)
[View article](#)
[PDF](#)

OPEN ACCESS

012150

Hematological and immunological profile of ART-Naïve HIV-infected patients in Bali-Indonesia: a descriptive study

S A Aryastuti, S R Dewi, P N Cahyawati, K Suryana and S Masyeni

[+ Open abstract](#)
[View article](#)
[PDF](#)

OPEN ACCESS

012151

Detection *Escherichia Coli O157* contamination in soymilk from traditional market at Denpasar City

A A A L Paramasatiari, D M Sukrama and P Sutirtayasa

[+ Open abstract](#)
[View article](#)
[PDF](#)

OPEN ACCESS

012152

Synthesis of ^{99m}Tc(V)-DMSA and radiolabelling of SPIO nanoparticles

E Sintya

[+ Open abstract](#)
[View article](#)
[PDF](#)

OPEN ACCESS

012153

Nutritional status of children in Bali-Indonesia

D A A S Astini

This site uses cookies. By continuing to use this site you agree to our use of cookies. To find out more, see our [Privacy and Cookies](#)
[+ Open abstract](#)
[View article](#)
[PDF](#)

-
- OPEN ACCESS** 012154
Relationship between work position and the occurrence of low back pain among aircraft maintenance engineer of PT. GMF AeroAsia at Ngurah Rai International Airport
N W V Aparajita and D A A S Astini
[+](#) Open abstract [View article](#) [PDF](#)
-
- OPEN ACCESS** 012155
The relationship between self-regulated learning and academic achievement of undergraduate medical students
R K Ningrum, A Kumara and Y S Prabandari
[+](#) Open abstract [View article](#) [PDF](#)
-
- OPEN ACCESS** 012156
Increasing trend of penile cancer cases in Bali compared to other regions in Indonesia
D P O Lestari and N W Armerinayanti
[+](#) Open abstract [View article](#) [PDF](#)
-
- OPEN ACCESS** 012157
Anaerobic capacity and blood lactate level of former elite athletes
N Nasuka, I Santosa, A Setiowati and F Indrawati
[+](#) Open abstract [View article](#) [PDF](#)
-
- OPEN ACCESS** 012158
Application of model development of soccer physical tests
H Hartati, A R Victorian, S Aryanti, D Destriana and D Destriani
[+](#) Open abstract [View article](#) [PDF](#)
-
- OPEN ACCESS** 012159
The development of instructional media for rhythmic gymnastics in physical education course
A Suherman, J Julia and T Supriyadi
[+](#) Open abstract [View article](#) [PDF](#)
-
- OPEN ACCESS** 012160
Green advertising, green brand image and green awareness for environmental products
D P Alamsyah, T Suhartini, Y Rahayu, I Setyawati and O I B Hariyanto
[+](#) Open abstract [View article](#) [PDF](#)
-
- OPEN ACCESS** 012161
Development of lecturer capacity in higher education: solution reduces burn out by design E-Tri-Angle
H Sukrisno, L T Muharlisiani and D Chamidah
[+](#) Open abstract [View article](#) [PDF](#)
-
- OPEN ACCESS** 012162
Public service motivation and job satisfaction as predictors of organizational citizenship behaviour
H S Wanto, A Arfah and E Siswati
[+](#) Open abstract [View article](#) [PDF](#)
-
- OPEN ACCESS** 012163
Promoting local culture through digital learning media
E E Nikmawati, I Widiaty, R Hurriyati, Y Achdiani, S R Mubaraq, A R Islami and M A Latif
[+](#) Open abstract [View article](#) [PDF](#)
-
- This site uses cookies. By continuing to use this site you agree to our use of cookies. To find out more, see our [Privacy and Cookies policy](#).
- OPEN ACCESS** 

Analysis of eco-friendly preference and eco-friendly product quality; their implications to customer satisfaction 012164

D S Soegoto

[+ Open abstract](#) [View article](#) [PDF](#)

OPEN ACCESS 012165

Going paperless: executive information system toward digitalized universities management

E S Soegoto and S Luckyardi

[+ Open abstract](#) [View article](#) [PDF](#)

OPEN ACCESS 012166

Increasing productivity in SMEs Samiler crackers by implementing appropriate technology

A D Witjaksono, A Susanti and A Frianto

[+ Open abstract](#) [View article](#) [PDF](#)

OPEN ACCESS 012167

Online taxi and green sustainable concept: what the literature says?

O C Ambarwati, R A Nugroho and D G Suharto

[+ Open abstract](#) [View article](#) [PDF](#)

OPEN ACCESS 012168

Organizational management and employees performance in banking services

R Kurniawati

[+ Open abstract](#) [View article](#) [PDF](#)

OPEN ACCESS 012169

The development of market segmentation of sorghum products as functional beverages

E Noerhartati, T Widiartin, M Maslihah and N W Karyanto

[+ Open abstract](#) [View article](#) [PDF](#)

OPEN ACCESS 012170

Feasibility study of electricity power plant from biogas by utilizing the liquid waste of palm oil mill in Aceh Province

N Nuaini, H Hamdani and T A Rizal

[+ Open abstract](#) [View article](#) [PDF](#)

OPEN ACCESS 012171

Application T-History method on measurement of thermal properties of phase change material as latent heat storage in solar water heating system

R Thaib, M Riza, M Amin and S Rizal

[+ Open abstract](#) [View article](#) [PDF](#)

OPEN ACCESS 012172

Numerical study of Savonius wind turbine with additional fin blade using computational fluid dynamic

B Anggara, I Widiastuti and H Saputro

[+ Open abstract](#) [View article](#) [PDF](#)

OPEN ACCESS 012173

Reduction in power consumption of refrigerator by using parallel expansion

E T Berman, D Supriawan, M Komaro and M Mutaufiq

[+ Open abstract](#) [View article](#) [PDF](#)

This site uses cookies. By continuing to use this site you agree to our use of cookies. To find out more, see our [Privacy and Cookies](#)

OPEN ACCESS



- Performance and flow visualization of Sukhoi Su-30MKI like model using GAMA water tunnel 012174
Z Anwar, S Sutrisno, B W Setyawan, R S Firdaus and F N Wega
[+](#) Open abstract [View article](#) [PDF](#)
-
- OPEN ACCESS** 012175
Efficiency of material consumption in sustainable conventional machining practices
B R Setiadi, S Setuju, T Sukardi and S Sugiyono
[+](#) Open abstract [View article](#) [PDF](#)
-
- OPEN ACCESS** 012176
Experimental study of local pitch variations on electric power generated by counter rotating wind turbine with single generator without gearbox
R Z Muhtadi and M A Bramantya
[+](#) Open abstract [View article](#) [PDF](#)
-
- OPEN ACCESS** 012177
Numerical study of gasification pelletized municipal solid waste using multi-stage air inlet downdraft gasifier
A R Saleh, B Sudarmanta and D R Ependi
[+](#) Open abstract [View article](#) [PDF](#)
-
- OPEN ACCESS** 012178
The analysis of carbide particles distribution of HSS performances in relation with the machining process in manufacturing workshops
A Setiadi, A Hamdani, A H Sasmita and Y Yayat
[+](#) Open abstract [View article](#) [PDF](#)
-
- OPEN ACCESS** 012179
The cooling effectiveness of the V-ixion motorcycle radiator using water coolant variation
A Akbar, R Firdaus and N Cahyono
[+](#) Open abstract [View article](#) [PDF](#)
-
- OPEN ACCESS** 012180
Work based learning in motorcycle classroom
D Hafid and A Gafar
[+](#) Open abstract [View article](#) [PDF](#)
-
- OPEN ACCESS** 012181
The improvement of synthetic gas quality on the gasification process of palm starch waste through the applied of cyclone separator
H Saputro, S Supriyadi, I Muttaqin, V Fadlullah, L Fitriana, T Firdani, R Muslim, K Khaniffudin, S Lasmini and V L P Sutrisno
[+](#) Open abstract [View article](#) [PDF](#)
-
- OPEN ACCESS** 012182
The basic investigation of evaporation rate and burning temperature of various type of liquid fuels droplet
L Fitriana, R A A Nugroho, H Saputro, T Firdani, R Muslim, B W Gumelar, H Setyaningrum, H A Ismunandar, R A Zainudin, W Rahmadi *et al*
[+](#) Open abstract [View article](#) [PDF](#)
-
- OPEN ACCESS** 012183
The effect of surface roughness on dynamic behaviour of the successive multiple droplets impacting onto aluminium hot surfaces
This site uses cookies. By continuing to use this site you agree to our use of cookies. To find out more, see our Privacy and Cookies policy.
M L Hakim, T Wibowo, A Widyatama, D Deendarlianto and I Indarto



[+ Open abstract](#) [View article](#) [PDF](#)

OPEN ACCESS 012184

Preliminary study of pellets Refuse Derived Fuel (RDF-5) based on Durian waste for feedstock in fast pyrolysis

H Saputro, D N Liana, A Firdaus, M Mahmudin, B Evan, B S Karsa, V L Perdana, D S Wijayanto, H Bugis and L Fitriana

[+ Open abstract](#) [View article](#) [PDF](#)

OPEN ACCESS 012185

Gasification modelling method using energy Gibbs minimum of palm starch solid waste

R Muslim, H Saputro, T Firdani, S Lasmini, K Khaniffudin, D S Wijayanto, L Fitriana, F A Munir and V L P Sutrisno

[+ Open abstract](#) [View article](#) [PDF](#)

OPEN ACCESS 012186

Numerical simulation analysis on the thermal performance of a building walls incorporating Phase Change Material (PCM) for thermal management

H Hamdani, S Rizal and M Riza

[+ Open abstract](#) [View article](#) [PDF](#)

OPEN ACCESS 012187

Development of media learning practice welding pipe position vertical axis (2G) with Gas Metal Arc Welding process (GMAW) in senior high school

Z Mutaqin, S Soemarto and C Suarti

[+ Open abstract](#) [View article](#) [PDF](#)

OPEN ACCESS 012188

Hydrate mitigation for subsea production multiphase pipeline by flow assurance approach

K Hartono, M Ginting, D Sulistyanto and R Karono

[+ Open abstract](#) [View article](#) [PDF](#)

OPEN ACCESS 012189

Optimization of Empty Fruit Bunches (EFB) as a solution to deforestation as a result of the exploitation from the paper industry in Riau of conferences

F S Irwansyah, J Yanto, W D I Azis and Kelvin

[+ Open abstract](#) [View article](#) [PDF](#)

OPEN ACCESS 012190

Online based performance assessment for general chemistry laboratory

S Sari, S A Ferawati, I Farida, O Sobandi and R Kariadinata

[+ Open abstract](#) [View article](#) [PDF](#)

OPEN ACCESS 012191

Enhanced antibiofouling properties of chitosan-based membranes by coating and blending of Moringa Oleifera L extracts

M K Pratiwi, L Masyrifah, L C Hawa, S R Dewi, N Izza, B D Argo, S Sucipto and Y Wibisono

[+ Open abstract](#) [View article](#) [PDF](#)

OPEN ACCESS 012192

Compression strength testing model on clay soil stabilization using variations of cement composition

F Chairuddin and Evelyn

[+ Open abstract](#) [View article](#) [PDF](#)

This site uses cookies. By continuing to use this site you agree to our use of cookies. To find out more, see our [Privacy and Cookies policy](#).

012192

The potential of styrogravel concrete as a new concrete material for building structures

Soerjandani P Machmoed and Utari Khatulistiani

[+ Open abstract](#)
[View article](#)
[PDF](#)
OPEN ACCESS

012194

Analysis of contractor company requirements on the competence of construction project management for graduates of civil engineering degree

Soepriyono, S Azizah and M Huda

[+ Open abstract](#)
[View article](#)
[PDF](#)
OPEN ACCESS

012195

Public transport service relating to safety

I Farida

[+ Open abstract](#)
[View article](#)
[PDF](#)
OPEN ACCESS

012196

Development of civil engineers' certification system evaluation model

I Widasanti, R Z Tamin, P F Marzuki and I I Wiratmaja

[+ Open abstract](#)
[View article](#)
[PDF](#)
OPEN ACCESS

012197

Development length on concrete with bundle bars

E Walujodjati

[+ Open abstract](#)
[View article](#)
[PDF](#)
OPEN ACCESS

012198

Enhancing the Strength of Volcanic Mud-based Class C Fly Ash Geopolymer Specimen by Limestone Inclusion

A Wardhono, N Estidarsani and N W Hidajati

[+ Open abstract](#)
[View article](#)
[PDF](#)
OPEN ACCESS

012199

Shear Capacity Analysis of High-Strength Reinforced Concrete Beams using Geopolymer Flyash and Palm Oil Blast Furnace Slag as Additives and Aggregate Substitution

T B Aulia, Muttaqin, M Afifuddin, M Zaki and S Merriza

[+ Open abstract](#)
[View article](#)
[PDF](#)
OPEN ACCESS

012200

Implementation of Transit Oriented Development in Handling Congestion Effect on Urban Sprawl Phenomenon and Traffic Growth in Banda Aceh

N Fadhly and R Matondang

[+ Open abstract](#)
[View article](#)
[PDF](#)
OPEN ACCESS

012201

Development of Smart Infusion Control and Monitoring System (SICoMS) Based Web and Android Application

M Yusro and Rikawarastuti

[+ Open abstract](#)
[View article](#)
[PDF](#)
OPEN ACCESS

012202

Based Fuzzy Logic Temperature Control for a Coffee Roaster Machine

M Fauziyah, S Adhisuwignjo, M Rifai and D Dewatama

[+ Open abstract](#)
[View article](#)
[PDF](#)

This site uses cookies. By continuing to use this site you agree to our use of cookies. To find out more, see our [Privacy and Cookies policy](#).



OPEN ACCESS	012203
Webcam Application for Classrooms Monitoring	
A Latifah	
+ Open abstract View article PDF	
OPEN ACCESS	012204
Pan-Tilt Modelling for Face Detection	
A Latifah, Saripudin, H Aulawi and M A Ramdhani	
+ Open abstract View article PDF	
OPEN ACCESS	012205
DC Motor Speed Controller Design using Pulse Width Modulation	
A Faroqi, M A Ramdhani, F Frasetyio and A Fadhil	
+ Open abstract View article PDF	
OPEN ACCESS	012206
Volcansmart Early Warning Systems Based Land Surface Temperature at the Disaster-Prone Region of Merapi Volcano, Regency of Sleman	
S R Marudut, W S Bektı, N A Adi and S D R Suryo	
+ Open abstract View article PDF	
OPEN ACCESS	012207
Effect of alpha value change on thrust quadcopter Qball-X4 stability testing using backstepping control	
A T Nugraha, I Anshory and R Rahim	
+ Open abstract View article PDF	
OPEN ACCESS	012208
A Low-Cost Linear LED Driver for Light Bulb Based on Harmonic Standard	
M Afif, M Ramdhani, D Darlis and A Rizal	
+ Open abstract View article PDF	
OPEN ACCESS	012209
Very Short Term Load Forecasting Using Hybrid Regression and Interval Type -1 Fuzzy Inference	
J Jamaaluddin and I Robandi	
+ Open abstract View article PDF	
OPEN ACCESS	012210
A Robot Compliant Joint Control Development and Simulation using a Linear Control Approach	
I Siradjuddin, W T Wahono, A Murdani, S Adhsuwignjoi, A Setiawan, E Rohadi and R P Wicaksono	
+ Open abstract View article PDF	
OPEN ACCESS	012211
Dual-band Rectangular Microstrip Patch Antenna for LTE and BWA Application	
N Ismail, F Oktafiani, F Makmur, F D Ramadhan, M A Ramdhani and I Taufik	
+ Open abstract View article PDF	
OPEN ACCESS	012212
Artificial Light Energy Harvester Using Low Start Voltage Solar Cell	
H S Adi, R A Priramadhi and D Darlis	
+ Open abstract View article PDF	

This site uses cookies. By continuing to use this site you agree to our use of cookies. To find out more, see our [Privacy and Cookies policy](#).

OPEN ACCESS



Energy efficient transmitter for guided indoor navigation using visible light 012213

S Afifah, S Angelina, P Susanti, R A Priramadhi and D Darlis

[+ Open abstract](#) [View article](#) [PDF](#)

OPEN ACCESS 012214

Application of Bidirectional DC-DC Converter for Saving Energy on Photovoltaic

I Sulistiyowati, H Kurniawan, Jamaaluddin, E A Suprayitno and R Rahim

[+ Open abstract](#) [View article](#) [PDF](#)

OPEN ACCESS 012215

Distributed Generators Presence Impact to the Overall System Performance

Z Pane, S Suherman and R Sipahutar

[+ Open abstract](#) [View article](#) [PDF](#)

OPEN ACCESS 012216

Frost Preventive Control System of Freezer

E F Kumala, R A Priramadhi and P Pangaribuan

[+ Open abstract](#) [View article](#) [PDF](#)

OPEN ACCESS 012217

Fuel Efficiency Improvement with Water Methanol Injection for Internal Combustion Engine

M A A Sidiq, R A Priramadhi and E Susanto

[+ Open abstract](#) [View article](#) [PDF](#)

OPEN ACCESS 012218

Design Measuring Instrument Dust Based Internet of Things

S Syahririni, D Hadidjaja, A Ahfas, A Rahmansyah and S H Pramono

[+ Open abstract](#) [View article](#) [PDF](#)

OPEN ACCESS 012219

Analysis of Chilli Plant Physiology Conventional System, Green House Hydroponic Utilization System Using Fuzzy Logic

Alimuddin, D M Subrata, Nurmayulis, R O Khastini and R Arafiyah

[+ Open abstract](#) [View article](#) [PDF](#)

OPEN ACCESS 012220

Automatic Watering System in Plant House - Using Arduino

M Mediawan, M Yusro and J Bintoro

[+ Open abstract](#) [View article](#) [PDF](#)

OPEN ACCESS 012221

Design and Fabrication of a Simple Laboratory Ball Mill for Powder Coconut Shell Preparation as Raw Material of Biochar

M Rosi and S Viridi

[+ Open abstract](#) [View article](#) [PDF](#)

OPEN ACCESS 012222

Casting and Welding of Aluminium Matrix Composite Materials Reinforced by SiC Particles

P H Tjahjanti, F Hermansyah, L H Prasetya and M P T Sulistyanto

[+ Open abstract](#) [View article](#) [PDF](#)

This site uses cookies. By continuing to use this site you agree to our use of cookies. To find out more, see our [Privacy and Cookies](#)

OPEN ACCESS



Land utilization changing of Pelaba Pura and Druwe Desa on pre and post-reclamation in Serangan Island 012223

I G S Darmawan and I W W Sastrawan

[+](#) Open abstract [View article](#) [PDF](#)

OPEN ACCESS 012224

Changes in Rural Settlement to Improve Ancient Villages Conservation Quality in Bali-Indonesia

A A G Raka and I W Runa

[+](#) Open abstract [View article](#) [PDF](#)

OPEN ACCESS 012225

Implementation of User Anthropometry Bale "*Sakenem*" Buildings Based on Height *Saka* Measurement in Singapadu Tengah Village, Gianyar

I W Parwata, M Umiyati and A A G O Wisnumurti

[+](#) Open abstract [View article](#) [PDF](#)

OPEN ACCESS 012226

Conception of Spatial Dualism around the Banyan Tree in Denpasar, Indonesia

I K M Wijaya

[+](#) Open abstract [View article](#) [PDF](#)

OPEN ACCESS 012227

Water Distribution System of Petanu River Estuary for Coastal Area in Bali-Indonesia

I G A P Eryani and A A R S Laksmi

[+](#) Open abstract [View article](#) [PDF](#)

OPEN ACCESS 012228

Physical Exercises Effectiveness in Controlling Diabetes Mellitus in the Elderly Group in Bali - Indonesia

T Subrata, A Lestarini and K Sari

[+](#) Open abstract [View article](#) [PDF](#)

OPEN ACCESS 012229

The Influence of Farmer's Characteristic on ζ at 'Simantri' Program in Bali

I G A M P Sanjaya

[+](#) Open abstract [View article](#) [PDF](#)

OPEN ACCESS 012230

The Intensity of Leaf Rust Disease, Growth and Yield of Chrysanthemum on Concentration and Time of Giving *Paenibacillus Polymixa* Biological Agent

A A S P R Andriani, Y P Situmeang, N P A Sulistiawati and G I Setiawan

[+](#) Open abstract [View article](#) [PDF](#)

OPEN ACCESS 012231

Biochar Bamboo Application on Growth and Yield of Red Amaranth (*Amaranthus tricolor* L)

Y P Situmeang, M Suarta, I K Irianto and A A S P R Andriani

[+](#) Open abstract [View article](#) [PDF](#)

OPEN ACCESS 012232

The Micronutrient Contents of Composting from Empty Bunch after Added Palm Oil Mill Effluent

I U P Rangkuti, Giyanto, R Novayanty, P M Raja and Zakwan

[+](#) Open abstract [View article](#) [PDF](#)

This site uses cookies. By continuing to use this site you agree to our use of cookies. To find out more, see our Privacy and Cookies

[policy](#)



- Development of SMS Gateway Information System for Detecting Air Quality 012233
Sudarsono, M A Novianta and Purnawan
[+ Open abstract](#) [View article](#) [PDF](#)
-
- OPEN ACCESS** 012234
An Investigation of Oxygen Need Based on Green Open Space in Indonesia University of Education (UPI) Campus Bandung
Sahid, D Rohmat, Y Malik and L Wahyuni
[+ Open abstract](#) [View article](#) [PDF](#)
-
- OPEN ACCESS** 012235
In Situ Measurement of Soil Carbon with Depth using Near Infrared (NIR) Spectroscopy
B H Kusumo
[+ Open abstract](#) [View article](#) [PDF](#)
-
- OPEN ACCESS** 012236
Development of Instructional Media Environmental-based Child Blood Type Detector Cardboard (KAPODA) Formal and Informal Education
D Yatimah, R Puspitaningrum, Solihin and Adman
[+ Open abstract](#) [View article](#) [PDF](#)
-
- OPEN ACCESS** 012237
Above-Ground Biomass and Carbon Stocks in Sigogor Mountain Nature Reserve, Ponorogo, East Java, Indonesia
N T Waskitho and J Triwanto
[+ Open abstract](#) [View article](#) [PDF](#)
-
- OPEN ACCESS** 012238
Design Evaluation of Biological Unit as a Basic Consideration to Determine the Design Criteria of Domestic Wastewater Treatment Plant at 1st Zone, Jakarta
T Tazkiaturrizki, R Ratnaningsih and S Aphirta
[+ Open abstract](#) [View article](#) [PDF](#)
-
- OPEN ACCESS** 012239
The Urgency of Establishment International Outer Space Authority as Embodiment of Outer Space Environment Protection
T Suharti and M T Kumala
[+ Open abstract](#) [View article](#) [PDF](#)
-
- OPEN ACCESS** 012240
Combine project management and economic order quantity: Is it valuable on food industry?
L Nurwandi
[+ Open abstract](#) [View article](#) [PDF](#)
-
- OPEN ACCESS** 012241
Analysis of Lighting Condition in Cutting Area
D Wahyuni, N Panjaitan, I Budiman and M Sitorus
[+ Open abstract](#) [View article](#) [PDF](#)
-
- OPEN ACCESS** 012242
Improving Innovation Capability Trough Creativity and Knowledge Sharing Behavior
H Aulawi
[+ Open abstract](#) [View article](#) [PDF](#)

-
- OPEN ACCESS** 012243
DRP: Joint Requirement Planning in Distribution Centre and Manufacturing
I Rizky, K Syahputri, R M Sari, I Siregar, M M Tambunan and Anizar
[+ Open abstract](#) [View article](#) [PDF](#)
-
- OPEN ACCESS** 012244
Application of Productivity Index with Craig Harris Method on Tea Product
I Rizky, K Syahputri, R M Sari, I Siregar, Erwin, U Tarigan and K Siregar
[+ Open abstract](#) [View article](#) [PDF](#)
-
- OPEN ACCESS** 012245
The Evaluation of Research and Development Division through Product Development Process in Biopharmaceutical Company
E S Hariandja
[+ Open abstract](#) [View article](#) [PDF](#)
-
- OPEN ACCESS** 012246
Assessment of technology content level with integrated technometrics and Analytical Hierarchy Process (AHP) methods in small and medium enterprises
W Sulistiyowati and R B Jakaria
[+ Open abstract](#) [View article](#) [PDF](#)
-
- OPEN ACCESS** 012247
Innovation and technology diffusion in agricultural sector
H Ainissyifa, E R Wulan, A Muhyiddin and M A Ramdhani
[+ Open abstract](#) [View article](#) [PDF](#)
-
- OPEN ACCESS** 012248
The determination of regional development priorities
H Aulawi, W A Kurniawan, D M Arifin and E J Hayat
[+ Open abstract](#) [View article](#) [PDF](#)
-
- OPEN ACCESS** 012249
Indonesian consumer perception of food safety system in fish supply chain
H C Wahyuni, I A Saidi and W Sumarmi
[+ Open abstract](#) [View article](#) [PDF](#)
-
- OPEN ACCESS** 012250
Green computing on registration system and transaction report in Serviam credit union
D S Bataona, F Liantoni, F E Laumal, R A Wadu, G C Manulangga, P W Sudarmadji and K A T Ole
[+ Open abstract](#) [View article](#) [PDF](#)
-
- OPEN ACCESS** 012251
Comparison of mobile learning applications in classroom learning in vocational education technology students based on usability testing
Sugiyanto and Agus Setiawan
[+ Open abstract](#) [View article](#) [PDF](#)
-
- OPEN ACCESS** 012252
Workload self-evaluation base on expert system for vocational teacher
K K M Pajung, Soemarto and A Setiawan
[+ Open abstract](#) [View article](#) [PDF](#)
-
- This site uses cookies. By continuing to use this site you agree to our use of cookies. To find out more, see our [Privacy and Cookies](#)



-
- OPEN ACCESS** 012253
Build sorghum database for developing SEU digital network on sorghum website of Wijaya Kusuma Surabaya University
T Widiartin and E Noerhartati
[+ Open abstract](#) [View article](#) [PDF](#)
-
- OPEN ACCESS** 012254
Information system to measure healthy home
N Saurina, E Wahyuningtyas, T S Rini, S W Purwaningrum and F S Rejeki
[+ Open abstract](#) [View article](#) [PDF](#)
-
- OPEN ACCESS** 012255
Sentiment analysis on Bahasa Indonesia tweets using Unigram models and machine learning techniques
B H Iswanto and V Poerwoto
[+ Open abstract](#) [View article](#) [PDF](#)
-
- OPEN ACCESS** 012256
Conceptual model of executive information system data (A Case Study at The State Islamic University of Sunan Gunung Djati Bandung)
M Irfan, W B Zulfikar, C N Alam, D Saadillah M and R S Fuadi
[+ Open abstract](#) [View article](#) [PDF](#)
-
- OPEN ACCESS** 012257
Analyzes of cybercrime expansion in Indonesia and preventive actions
M Irfan, M A Ramdhani, W Darmalaksana, A Wahana and R G Utomo
[+ Open abstract](#) [View article](#) [PDF](#)
-
- OPEN ACCESS** 012258
Architecture of human resource management system at universities
R Setiawan
[+ Open abstract](#) [View article](#) [PDF](#)
-
- OPEN ACCESS** 012259
Designing library information system using rapid application development method
A D Supriatna
[+ Open abstract](#) [View article](#) [PDF](#)
-
- OPEN ACCESS** 012260
Designing academic advising information system using prototyping method
A D Supriatna, R Kurniawati and D D S Fatimah
[+ Open abstract](#) [View article](#) [PDF](#)
-
- OPEN ACCESS** 012261
Feature Extraction ElectroEncephaloGram (EEG) using wavelet transform for cursor movement
H Hindarto, A Muntasa and S Sumarno
[+ Open abstract](#) [View article](#) [PDF](#)
-
- OPEN ACCESS** 012262
Blended learning development for vocational education
Y Sukrawan, Soemarto and M Komaro
[+ Open abstract](#) [View article](#) [PDF](#)
-
- This site uses cookies. By continuing to use this site you agree to our use of cookies. To find out more, see our [Privacy and Cookies](#)



OPEN ACCESS	012263
Understanding students behavior during the adoption of modular robotics in learning	
F Kamal, C W Budiyanto and A Efendi	
+ Open abstract View article PDF	
OPEN ACCESS	012264
Interaction of traffic police with motorized vehicle control by CCTV	
U Enggarsasi and N K Sa'diyah	
+ Open abstract View article PDF	
OPEN ACCESS	012265
Analysis of implementation Augmented Reality (AR) introduction of temple and ancient objects based on android to increasing student learning outcomes	
R Agustina, E Sutadji, Purnomo, D Suprianto, E Kusumawati, M N D Hudha and M Afif	
+ Open abstract View article PDF	
OPEN ACCESS	012266
Development of instructional multimedia for mathematics based on adobe flash and Wondershare quiz creator	
Y N Rahayu, R Kariadinata, Z Fariansyah, R P Yaniawati and H Sugilar	
+ Open abstract View article PDF	
OPEN ACCESS	012267
Internet-based social media and its influence on student behaviour changes	
S Sriadhi, S Gultom, R Restu, R Rahim and J Simarmata	
+ Open abstract View article PDF	
OPEN ACCESS	012268
Algebraic experience material with lectors inspire	
H Sugilar, I Nuraida, F S Irwansyah and M A Ramdhani	
+ Open abstract View article PDF	
OPEN ACCESS	012269
Developing vocational synthetic video motion learning using motor slider	
Tri Wrahatnolo, Setya Chendra Wibawa, Lilik Anifah, IGP Asto Buditjahjanto and Wiyli Yustanti	
+ Open abstract View article PDF	
OPEN ACCESS	012270
Design applications of apprenticeship productive teaching monitoring systems	
Kostaman, M S Barliana, A Setiawan and Ana	
+ Open abstract View article PDF	
OPEN ACCESS	012271
Representation of media literacy in the dimensions of social life in Indonesia	
K Y S Putri, S B Istiyanto and L Sugiyanta	
+ Open abstract View article PDF	
OPEN ACCESS	012272
The implementation of voice over internet protocol on private automatic branch exchange using analog telephone adapter	
Eki Ahmad Zaki Hamidi, Muhammad Ali Ramdhani, Angga Ahmad Nuronsi and Mufid Ridlo Effendi	
+ Open abstract View article PDF	

This site uses cookies. By continuing to use this site you agree to our use of cookies. To find out more, see our Privacy and Cookies policy.



-
- OPEN ACCESS** 012273
Teaching network security in Linux using Netkit with implementation virtual laboratory
Y Ariyanto, B Harijanto and Y W Syaifudin
[+ Open abstract](#) [View article](#) [PDF](#)
-
- OPEN ACCESS** 012274
A comprehensive study on MQTT as a low power protocol for internet of things application
M V Masdani and D Darlis
[+ Open abstract](#) [View article](#) [PDF](#)
-
- OPEN ACCESS** 012275
Packet size impact on the 802.11 network performances
S Suherman
[+ Open abstract](#) [View article](#) [PDF](#)
-
- OPEN ACCESS** 012276
Development of virtual laboratory of food microbiology-based websites
F Ramdani, S Handayani and B Firdiana
[+ Open abstract](#) [View article](#) [PDF](#)
-
- OPEN ACCESS** 012277
Comparing genres of Indonesian literature by utilizing big data
M Rokib, S Anam, E Rahmawati, S Sodik and P Retnaningdyah
[+ Open abstract](#) [View article](#) [PDF](#)
-
- OPEN ACCESS** 012278
User interface modelling by implementing storytelling on Sundanese cultural introduction media for early childhood using child-centered design method
O D J Ayuningtyas, V Effendy and E R Kaburuan
[+ Open abstract](#) [View article](#) [PDF](#)
-
- OPEN ACCESS** 012279
Literacy and benefits of OER concept for prospective vocational high school teachers
Saripudin, A Djohar, D Rohendi and A G Abdullah
[+ Open abstract](#) [View article](#) [PDF](#)
-
- OPEN ACCESS** 012280
Filter bubble effect and religiosity: filter bubble effect implication in the formation of subjects and views of religiosity
T Zakaria, B Busro and S Furqon
[+ Open abstract](#) [View article](#) [PDF](#)
-
- OPEN ACCESS** 012281
Question-answer pair templates based on bloom's revised taxonomy
C Juliane, A A Armant, H S Sastramihardja and I Supriana
[+ Open abstract](#) [View article](#) [PDF](#)
-
- OPEN ACCESS** 012282
Determinant factors in multimedia-based e-learning design
M K Umana
[+ Open abstract](#) [View article](#) [PDF](#)
-
- [+ Open abstract](#) [View article](#) [PDF](#)

This site uses cookies. By continuing to use this site you agree to our use of cookies. To find out more, see our [Privacy and Cookies policy](#).



-
- OPEN ACCESS** 012283
The development of creative instructional program for architecture studio course
H I Dewi, Yufiarti and D N Musnir
[+](#) Open abstract [View article](#) [PDF](#)
-
- OPEN ACCESS** 012284
The role of higher education in society activation through digital mural in ASEAN cities
D Trihanondo and D Endriawan
[+](#) Open abstract [View article](#) [PDF](#)
-
- OPEN ACCESS** 012285
How important is technological, pedagogical, content knowledge? A literature reviews
J Mupita, I Widiaty and A G Abdullah
[+](#) Open abstract [View article](#) [PDF](#)
-
- OPEN ACCESS** 012286
Laboratory management: digital laboratory information system (DLIS) concept
I Fushshilat, A Rahmat, Y Somantri and E Haritman
[+](#) Open abstract [View article](#) [PDF](#)
-
- OPEN ACCESS** 012287
Electrical fall (EFA) as a learning media for electromagnetic induction
E K Yuningsih, M M Chusni and R Sidik
[+](#) Open abstract [View article](#) [PDF](#)
-
- OPEN ACCESS** 012288
HATRAVY: a virtual laboratory of heat transfer concept in microscopic form
H Y Suhendi, D Mulhayatiah, R Anjani, M A Ramdani and R Ardiansyah
[+](#) Open abstract [View article](#) [PDF](#)
-
- OPEN ACCESS** 012289
Identification of subsurface basement rock using geoelectrical resistivity method in development area (campus 2 UIN Sunan Gunung Djati Bandung)
R D Agustina, H Pazha and H Sugilar
[+](#) Open abstract [View article](#) [PDF](#)
-
- OPEN ACCESS** 012290
Learning motion through the learning cycle model
S Sari, F F Rengganis, A Saepudin, F S Irwansyah and O Sobandi
[+](#) Open abstract [View article](#) [PDF](#)
-
- OPEN ACCESS** 012291
Recovery of soil arthropods after 1-year forest fires in Mount Merapi National Park Yogyakarta
M Sholikha, T S Djohan, J Subagja and T Kurniati
[+](#) Open abstract [View article](#) [PDF](#)
-
- OPEN ACCESS** 012292
Sterilization Method of *Etilingera Elatior* Explant on Tissue Culture
L Chaidir, S Isnaini, C Hidayat, S Hasani, N Wicaksana and J Syantiara
[+](#) Open abstract [View article](#) [PDF](#)
-
- This site uses cookies. By continuing to use this site you agree to our use of cookies. To find out more, see our [Privacy and Cookies policy](#).
- OPEN ACCESS** 

The development of students' entrepreneurial attitudes in the learning of milk kefir processing 012293

R Aisyah, S M Dakhlan and N Windayani

[+ Open abstract](#) [View article](#) [PDF](#)

OPEN ACCESS 012294

Adaptive multimedia with android e-assessment to improve assessment efficiency

S D Aji, M N Hudha, C Huda, Z Khoiro, W Wartono, J R Batlolona, S Alfarisa, A B D Nandiyanto and A G Abdullah

[+ Open abstract](#) [View article](#) [PDF](#)

OPEN ACCESS 012295

Acceptance finding ability

I Isrokatun, N Hanifah and M Maulana

[+ Open abstract](#) [View article](#) [PDF](#)

OPEN ACCESS 012296

Utilization cow urine and liquid organic fertilizer weed to production of tomato varieties timoti F1

Y Setiati, C Hidayat, Y Deriska and M Mulyana

[+ Open abstract](#) [View article](#) [PDF](#)

OPEN ACCESS 012297

Influence of sweet potato types on physical and sensory characteristics pure of sweet potato soup (*ipomoea batatas* L)

T Setiawati, S Sudewi and A Mahmudatussa'adah

[+ Open abstract](#) [View article](#) [PDF](#)

OPEN ACCESS 012298

Development of Standard Operational Procedure (SOP) for the implementation of lath machining practice in Vocational High School (SMK)

R C Putra, K Sumardi, M Komaro and A G Abdullah

[+ Open abstract](#) [View article](#) [PDF](#)

OPEN ACCESS 012299

Development of design monitoring and electricity tokens top-up system in two-ways energy meters based on IoT (Internet of Things)

V S Erlinda, A G Abdullah and K Astami

[+ Open abstract](#) [View article](#) [PDF](#)

OPEN ACCESS 012300

Photographic skill competency for vocational high school

I Maulana, S Sumarto, D L Hakim and A G Abdullah

[+ Open abstract](#) [View article](#) [PDF](#)

OPEN ACCESS 012301

Design and implementation of web-based internship information system at vocational school

Y Yannuar, B Hasan, A G Abdullah, D L Hakim and D Wahyudin

[+ Open abstract](#) [View article](#) [PDF](#)

OPEN ACCESS 012302

Requirement analysis of work competence of vocational graduates in heavy equipment industry

E P Asfiyanur, K Sumardi, A Hamdani and A G Abdullah

[+ Open abstract](#) [View article](#) [PDF](#)

This site uses cookies. By continuing to use this site you agree to our use of cookies. To find out more, see our Privacy and Cookies policy.



-
- OPEN ACCESS** 012303
Does digital curriculum mapping improve curriculum alignment?
I Khoerunnisa, I Widiaty, A G Abdullah and I Kuntadi
[+ Open abstract](#) [View article](#) [PDF](#)
-
- OPEN ACCESS** 012304
Application of expert system for education
G Supriyanto, I Widiaty, A G Abdullah and J Mupita
[+ Open abstract](#) [View article](#) [PDF](#)
-
- OPEN ACCESS** 012305
Automated curriculum alignment standards in K-12 schooling system
M Muktiarni, I Widiaty, A G Abdullah and I Kuntadi
[+ Open abstract](#) [View article](#) [PDF](#)
-
- OPEN ACCESS** 012306
Increasing dissolution rate of telmisartan tablet by dispersion method
M A Dhina, D A Deswati and S R Mubaroq
[+ Open abstract](#) [View article](#) [PDF](#)
-
- OPEN ACCESS** 012307
Designing a content setting application on youtube in learning batik in a vocational school
I Widiaty, L S Riza, A Ana, A G Abdullah, S R Mubaroq and M Abdullah
[+ Open abstract](#) [View article](#) [PDF](#)
-
- OPEN ACCESS** 012308
Fuzzy system application in education
R Ilahi, I Widiaty and A G Abdullah
[+ Open abstract](#) [View article](#) [PDF](#)
-
- OPEN ACCESS** 012309
Integrating SAMR learning model in vocational education
A Aprinaldi, I Widiaty and A G Abdullah
[+ Open abstract](#) [View article](#) [PDF](#)
-
- OPEN ACCESS** 012310
Renewable vs. conventional energy: which wins the race to sustainable development?
A S M Al-Obaidi and T NguyenHuynh
[+ Open abstract](#) [View article](#) [PDF](#)
-
- OPEN ACCESS** 012311
Waist to height ratio (0.5) as a predictor for prediabetes and type 2 diabetes in Indonesia
H S Djap, B Sutrisna, P Soewondo, R Djuwita, K H Timotius, Trihono, S Sharif and Y S Tjang
[+ Open abstract](#) [View article](#) [PDF](#)
-
- OPEN ACCESS** 012312
Correlation of enhancement Platelet Distribution Width (PDW) with severity of dengue infection
S R Dewi, U Sukorini and U S Intansari
[+ Open abstract](#) [View article](#) [PDF](#)

The effects of soursop leaves extract on the islets of *langerhans* of the male *wistar* rats exposed to high fat diet and *streptozotocin*

D A A S Astini

[+ Open abstract](#) [View article](#) [PDF](#)

OPEN ACCESS

012314

Travel related infection among international travellers visiting clinics at Ubud Bali

KT Sumadewi, A Narendrakomaranatha, E Lalita, W Rusni, A E Pratiwi, N P D Witari and S Masyeni

[+ Open abstract](#) [View article](#) [PDF](#)

OPEN ACCESS

012315

MMPI-2Dx restructured clinical scale-based psychopathology among opioid dependence inmates in class IIA correctional facility Denpasar

A Primatanti

[+ Open abstract](#) [View article](#) [PDF](#)

OPEN ACCESS

012316

Severe falciparum malaria with acute kidney injury: a case report

N M A Kurnianingrum and N P Ayu

[+ Open abstract](#) [View article](#) [PDF](#)

OPEN ACCESS

012317

The influence of head lice (*pediculus humanus capitis*) infestation to nutritional status and anemia occurrence on female elementary school students

I P Sudayasa, A Arimaswati, M Abdullah and A R Masumi

[+ Open abstract](#) [View article](#) [PDF](#)

OPEN ACCESS

012318

Ergonomic approach decrease musculoskeletal complaints and increases productivity of *pindang* producers in Kusamba, Bali

I G S Pandit and P A N K Permatananda

[+ Open abstract](#) [View article](#) [PDF](#)

OPEN ACCESS

012319

Relationship between activities specific balance confidence (ABC) scale with age and falls on elderly in Wanasraya Nursing Home Denpasar

S Harkitasari

[+ Open abstract](#) [View article](#) [PDF](#)

OPEN ACCESS

012320

Urinary stone profile at Tabanan Hospital within July 2014 to June 2016

A N O Diatmika, D Santoso and I B T Yatindra

[+ Open abstract](#) [View article](#) [PDF](#)

OPEN ACCESS

012321

Viral subtyping of HIV-1 derived from infected, drug-naive individuals in Jakarta, Indonesia

A M Witaningrum, S Q Khairunisa, S Ueda, M Q Yunifiar, D W Indriati, T Kotaki, A Rusli, N Nasronudin and M Kameoka

[+ Open abstract](#) [View article](#) [PDF](#)

OPEN ACCESS

012322

Prevalence of hypertension among adults in Kintamani Subdistrict-Bali

This site uses cookies. By continuing to use this site you agree to our use of cookies. To find out more, see our Privacy and Cookies policy.



[+ Open abstract](#) [View article](#) [PDF](#)

OPEN ACCESS 012323

A rare widespread tuberculous spondylitis extended from the T5-T10 levels – a case report

L G Evayanti, V P Kalanjati and A Machin

[+ Open abstract](#) [View article](#) [PDF](#)

OPEN ACCESS 012324

Effect of statin on vascular wall thickness in kidney disease model

P N Cahyawati, N Arfian and N Ngatidjan

[+ Open abstract](#) [View article](#) [PDF](#)

OPEN ACCESS 012325

Dosage antioxidant drink sinom of β cell langerhans islet white mice spraque dawley diabetes mellitus

N K Wiradnyani

[+ Open abstract](#) [View article](#) [PDF](#)

OPEN ACCESS 012326

Are there any correlations between embolic stroke and previous post-traumatic epilepsy? – Study from a case report

W Santosa, V P Kalanjati and A Machin

[+ Open abstract](#) [View article](#) [PDF](#)

OPEN ACCESS 012327

The quality of life of patients with epilepsy in Denpasar: A cross sectional study

P A N K Permatananda, E Kristin, D Endarthy, R T Pinzon and I K Sumada

[+ Open abstract](#) [View article](#) [PDF](#)

OPEN ACCESS 012328

Endovascular laser ablation: minimally invasive intervention for klippel treunaunay syndrome

I G A M A Putra, N A Hidayat and P A N K Permatananda

[+ Open abstract](#) [View article](#) [PDF](#)

OPEN ACCESS 012329

Health risks associated with recreational water activities

L S Pakasi

[+ Open abstract](#) [View article](#) [PDF](#)

OPEN ACCESS 012330

Sensitization to food and pollen allergens and their implication for travelers with respiratory allergies

I Renganis and L S Pakasi

[+ Open abstract](#) [View article](#) [PDF](#)

OPEN ACCESS 012331

Methylphenidate augmentation during antidepressant treatment for depression in HIV: a case report

A Primatanti

[+ Open abstract](#) [View article](#) [PDF](#)

OPEN ACCESS 012332

Explorative study on risky sexual behaviour in tradeswomen in denpasar city

The Priatanti

This site uses cookies. By continuing to use this site you agree to our use of cookies. To find out more, see our [Privacy and Cookies policy](#).



[+ Open abstract](#) [View article](#) [PDF](#)

OPEN ACCESS 012333

Characteristic of eye disease on foreigners: a study of eye clinics in Bali

N M A Suryathi, I G A M Juliari, Y Khatania, I G A R Suryaningrum and N M A Surasmiati

[+ Open abstract](#) [View article](#) [PDF](#)

OPEN ACCESS 012334

Dialysis treatment in Indonesia: focus on Bali

I G R Widiana

[+ Open abstract](#) [View article](#) [PDF](#)

OPEN ACCESS 012335

Utilization review inpatient and outpatient of traveller related to thypoid in Bali (study in two regencies: a case report)

K T Sumadewi, P A Eka, S Masyeni, N W Rusni and N P D Witari

[+ Open abstract](#) [View article](#) [PDF](#)

OPEN ACCESS 012336

The venomous bites and stings: overview for travel medicine physicians

N M D D Sukmawati

[+ Open abstract](#) [View article](#) [PDF](#)

OPEN ACCESS 012337

Case report: management of nasal septal deviation with endoscopic septoplasty

A Santosa, D Permatasari and IBS Putera

[+ Open abstract](#) [View article](#) [PDF](#)

OPEN ACCESS 012338

Comparison of low and high DNA Purity for quantitative detection of ratio Mitochondrial and Nucleus DNA among Drug-treated HIV Patients by Real-time PCR

S Q Khairunisa, S Masyeni, A M Witaningrum and N Nasronudin

[+ Open abstract](#) [View article](#) [PDF](#)

OPEN ACCESS 012339

Cell culture models: Time course of cellular accumulation of ^{99m}Tc-HMPAO

E Sintya

[+ Open abstract](#) [View article](#) [PDF](#)

OPEN ACCESS 012340

Ocular Syphilis in HIV-positive Male

I G A M Juliari and N K N Susila

[+ Open abstract](#) [View article](#) [PDF](#)

OPEN ACCESS 012341

Rubella infection during first trimester of pregnancy, is it always termination of pregnancy? a case report

R Budayasa

[+ Open abstract](#) [View article](#) [PDF](#)

OPEN ACCESS 012342

Problematic issues surrounding deep vein treatment

This site uses cookies. By continuing to use this site you agree to our use of cookies. To find out more, see our Privacy and Cookies policy

Roliga



[+ Open abstract](#) [View article](#) [PDF](#)

OPEN ACCESS

012343

Students' perception of peer tutor roles in the small group discussion

R K Ningrum

[+ Open abstract](#) [View article](#) [PDF](#)

JOURNAL LINKS

[Journal home](#)

[Journal scope](#)

[Information for organizers](#)

[Information for authors](#)

[Contact us](#)

[Reprint services from Curran Associates](#)

PAPER • OPEN ACCESS

Developing vocational synthetic video motion learning using motor slider

To cite this article: Tri Wrahatnolo *et al* 2018 *IOP Conf. Ser.: Mater. Sci. Eng.* **434** 012269

View the [article online](#) for updates and enhancements.



IOP | ebooks™

Bringing you innovative digital publishing with leading voices to create your essential collection of books in STEM research.

Start exploring the [collection](#) - download the first chapter of every title for free.

Developing vocational synthetic video motion learning using motor slider

Tri Wrahatnolo^{1*}, Setya Chendra Wibawa², Lilik Anifah², IGP Asto Buditjahjanto² and Wiyli Yustanti²

¹Electrical Engineering, Universitas Negeri Surabaya, Indonesia

²Informatics Engineering, Universitas Negeri Surabaya, Indonesia

*t.wrahatnolo@unesa.ac.id

Abstract. We describe a method for improving the function of the manual slider to be an electrical slider with a technique to enhance the quality, making the effect and removing the undesired camera shakes. The moving of the camera ball head used belt strapped to a motor with a simple electronic circuit using IC regulator LM 317 that can set the speed of moving to the right or left. This study has the objective to help the making of the video e-learning so that the results can be optimized, can reduce the video image shake due to hand power limited, so the video like as professional video. This research using Research and Development Method (R&D). There are 10 steps according to the development of this model, namely the potential and problems, data collection, product design, design validation, design revisions, product testing, product revision, utility testing, product revision, and mass production. However, this study is limited to the following five steps to the first product revision. The conclusion that motor slider is overall valuable and well accepted educational tools to create video motion and the video results can be as video training.

1. Introduction

A video is a form of multimedia that conveys information through two simultaneous sensory channels: aural and visual. It often uses multiple presentation modes, such as verbal and pictorial representations in the case of on-screen print and closed-captioning [5,8]. Using audio-video materials in the classroom is nothing new since filmstrips were first studied during World War II as a training tool for soldiers [4] educators have recognized the power of audio-video materials to capture the attention of learners, increase their motivation and enhance their learning experience. Both the content and technology have developed considerably since that time, increasing the availability and the value of audio-video materials in the classroom. Media development mapped out by Barrett in as the table 1 below.



Table 1. Portfolio construction tool compared [3].

	Common Development Tools	Structure & Links	Player Available	Advantages	Disadvantages	Ease of Use* 1 = low skill 5 = high skill	Technology Required 1 = low tech 5 = high tech	Cost (with educator discount)
Relational Database	FileMaker Pro	Fields, records, or files linked by common fields	Yes	Flexible reporting, network-friendly, Web accessible, cross-platform	Size of files, requires player	4 to develop, 2 to use	3	\$65-156
Hypermedia	HyperStudio, Digital Chisel	Electronic cards linked by "buttons"	Yes	Widely available in classrooms, construction tools included, some software cross-platform	Not easily Web-accessible (requires browser plug-in), view limited to screen size	3 to develop	3	\$39-199
Multimedia Authoring	Macromedia Authorware, Director	Icon- or time-based environment	Self-contained	Most flexibility in development, CD-ROM, cross-platform	Steep learning curve	5	5	\$128-699
Web Pages	Adobe PageMill, Claris Home Page, Composer	Pages viewed with a Web Browser (Netscape or Internet Explorer) using links created in HTML	Browser (free)	Web-accessible, cross-platform	Multimedia (video) not well integrated, complex authoring	2 with editor, 4 without	4	Free-\$79
Adobe Acrobat	Adobe Acrobat Exchange	Postscript-based pages that can be navigated sequentially or by using bookmarks, links, or buttons	Reader (free)	Web accessible, cross-platform, create files from any application, ideal for CD-ROM, can capture Web pages with links	Size of files, limited construction tools	2	4	Exchange is \$42-90
Slideshows/ Presentations	Microsoft Works, PowerPoint, AppleWorks	Slideshow presentation or "Binder" (Microsoft Office) to link documents together	No	Widely accessible software, cross-platform	Not directly Web-accessible, difficult to create hyper text links, requires original application to read	3	3-4	\$46-210
Digital Video	QuickTime or AVI format, Movie Player Pro (for editing), Apple Video Player (for digitizing), Avid Cinema, iMovie	Record performances in and out of the classroom; digital video editing can be used to prepare artifacts for presentation	QuickTime, RealPlayer (both free)	Web access, high interactivity, random access, editing	File size, storage quality, bandwidth requirements, hardware requirements to digitize video	Level 5 skill needed to create digital video, although with tools such as Avid Cinema and iMovie, the learning curve is flatter	5 to use computers with video digitizing boards. Digital video cameras streamline the process, especially with the latest computers	Editing software from \$29 (Movie-Player Pro) to ≥\$500; DV cameras <\$1,000.
Analog Video	Video on tape: VHS, 8mm	Standard video used to capture performances in and out of the classroom; also a universal format for final presentation portfolio	All that is required is a VCR	Ubiquitous access, cheap storage, medium, acceptable quality, hardware requirements	Linear access, low interactivity, no Web access	Level 2 skill needed to create analog video, although editing analog videotape is more complicated	Can be recorded with low-end equipment	Other than the cost of a camera or VCR, the only additional cost is videotape; analog video editing system ≥ \$250; 8mm camera ≥ \$300

2. Literature review

An electronic circuit that is used to regulate the voltage of the motor shown in figure 1:

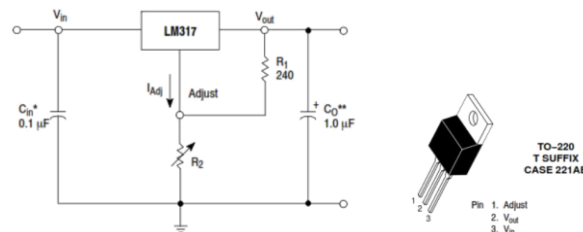

Figure 1. Electronic circuit using IC LM317.

Internal Short-Circuit Current Limiting Constant with Temperature, Output Transistor Safe-Area Compensation, Floating Operation for High Voltage Applications, Eliminates Stocking many Fixed Voltages, Available in Surface Mount D PAK-3, and Standard 3-Lead Transistor Package, NCV Prefix for Automotive and Other Applications Requiring Unique Site and Control Change Requirements; AEC-Q100 Qualified and PPAP Capable These are Pb-Free Devices. An electronic circuit using IC LM317 is an adjustable 3-terminal positive voltage regulator capable of supplying in excess of 1.5 A over an output voltage range of 1.2 V to 37 V. This voltage regulator is exceptionally easy to use and requires only two external resistors to set the output voltage. Further, it employs internal current limiting, thermal shutdown, and safe area compensation, making it essentially blow-out proof. The LM317 serves a wide variety of applications including local, on card regulation. This device can also be used to make a programmable output regulator, or by connecting a fixed resistor between the adjustment and output, the LM317 can be used as a precision current regulator [1].

The research conducted in developing online test application using CodeIgniter framework in Vocational High School (SMK). From the validator, it can be obtained from the media expert value of 81.25% which means the application is very valid and can be used. From the validation expert about the aspect of Validation, Content gets a valid value which means can be used, while the aspect of Language and Writing Problem gets a very understandable value which means can be used in testing. According to research by User Acceptance Testing (UAT), applications can be received very well by the students and can be used to do the final semester or midterm's exams [10].

An instructional media is needed to help students achieve the best learning outcome. The method used was Research and Development (R&D) using post-test-only in controlled quasi-experimental group design [8,11].

The terms Electronic Portfolio and Digital Portfolio are used interchangeably; however, there is a distinction. an Electronics Portfolio contains artifacts that may be in analog forms, such as a video tape, or may be in the computer-readable form: in a Digital Portfolio, all artifacts have been transformed into computer-readable form. An electronic portfolio is not a haphazard collection of artifacts (i.e., a digital scrapbook or a multimedia presentation) rather a reflective tool that demonstrates growth over time [3].

The use of video learning already explores [9]. Their research explores the uses of camera features on the cell phone to capture subjects in the creation of Javanese traditional wedding makeup using the traditional costumes of each area in Indonesia. The technique of taking a picture using mini glide cam which implemented to stabilize the video to eliminate shaking when still recording.

3. Method

The method of this research using the model of Research and Development (R & D) as figure 2. There are 10 steps according to the development of this model, (1) namely the potential and problems, (2) data collection, (3) product design, (4) design validation, (5) design revisions, (6) product testing, (7) product revision, (8) utility testing, (9) product revision, and (10) mass production. It takes an initial data collection to determine the potential and problem that could be developed and modify in the use of a manual slider to be an electric slider. Whether using the motor slider, can reduce the vibration video and the need for electronic circuits, as well as other supporting equipment. Then the design of electrical slider validated with the objective of motor slider design as the expectations. The next stage is the first test to determine the voltage requirement, if necessary, it needs to modification electronic circuits base on the basic circuit. This method is limited to utility testing.



Figure 2. Complete step using R&D method [11]

4. Results and discussion

This experiment using a design study with the Research and Development (R & D) [11] in 10 step, but this research is limited as: from the flowchart above can be explained namely: (1) Potential and

problems; the potential and problem that could be developed and modify in the use of a manual slider to be an electric slider.

Starting from a video produced some movement seen online courses can be unsightly and so we need a method or product that could dampen or reduce unwanted motion. The movement is commonly shaking when video camera recorder exposed for scratching or using the hand as a buffer that holds the camera well. Whereas the movement of the camera must be stable so that the resulting video does not disturb focus of learning and well received by learners, This study has the objective to help the making of the video e-learning so that the video results can be optimized, can reduce the video image shake due to hand power limited then the video like as professional.

Whether using the motor slider, can reduce the vibration video and the need for electronic circuits, as well as other supporting equipment. In this study, carried out a search on the website <http://vlearn.unesa.ac.id>, there is kind of video learning with unstable motion, unfocused video subject, (2) the Data Collection ; Once the potential and problems can be shown in a factual and up to date, we then need to collect a variety of data that can be used as material for planning a video e-materials are expected to be used as a solution and produce a video e -material stable in this research, data collecting: a) collect material that is suitable and can be used as a video, b) make concept story board video e-materials, c) collecting pictures, music, and materials used in the development of video material, d) e-journal relevant research, (3) Product design ; the product design stage, which is produced a prototype, making video e-materials. This stage starts with making a slider, installing the motor, installing a circuit of the simple electronic motor drive as figure 3.

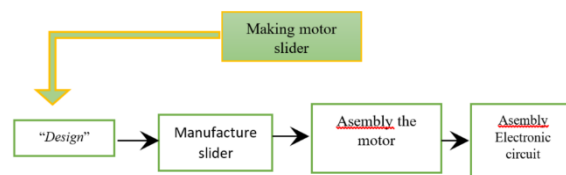

Figure 3. Step work on the manufacture of motor slider.



Figure 4. (a) slider without the motor (b) slider with motor circuit

Design Validation; validation is the process of product design activities to assess the product. Validation is done for research instruments such as the observation sheets filled by three expert lecturers, namely, materials experts, media experts, and linguists. In this case, the product is partially multimedia video material subjects. Validation is done by seven lecturers are experts, subject matter experts, media experts, and linguists. Rate on video covers three aspects are considered, namely: a) format media assessed to see the opening menu of applications, the harmony of colour display background with the text, the clarity of the instructions for use and the buttons function properly, b) the video format assessed the suitability of video material that haircut (Graduation), video quality, image clarity, clarity of narration or audio, the suitability of music illustrations to support the display and buttons function properly, c) the format of the material assessed the suitability of the material with the theory, text settings, selecting the model and size of the text, an explanation letter, and buttons function properly, (5) Product Revision ; this step is to revise form as assessment, update question

form, (6) Product Validation; validation is the process of product design activities to assess the product. Validation is done for research instruments such as the observation sheets filled by three expert lecturers, namely, materials experts, media experts, and linguists. In this case, the product is partially multimedia video material subjects. Validation using UAT [2,10] is done by 7 lecturers are experts, subject matter experts, media experts, and linguists. Rate on video covers three aspects are considered, namely: a) format media assessed to see the opening menu of applications, the harmony of colour display background with the text, the clarity of the instructions for use and the buttons function properly b) the video format assessed the suitability of video material that barbershop base women (Graduation), video quality, image clarity, clarity of narration or audio, the suitability of music illustrations to support the display and buttons function properly c) the format of the material assessed the suitability of the material with the theory, text settings, selecting the model and size of the text, an explanation letter, and buttons function properly, (7) Product Testing 1 ; this step is testing the slider to generate video with certain conditions such as the length of the slider x cm takes a few seconds, with a certain voltage, (8) Utility Testing ; furthermore, It is known that the IC need protection using a diode. By using the formula

$$V_{out} = 1.25V \left(1 + \frac{R_2}{R_1} \right) + I_{Adj} R_2 \quad (1)$$

When external capacitors are used with any IC regulator it is sometimes necessary to add protection diodes to prevent the capacitors from discharging through low current points into the regulator figure 4 shows the LM317 with the recommended protection diodes for output voltages in excess of 25 V or high capacitance values ($C_o > 25 \text{ } \mu\text{F}$, $C > 10 \text{ } \mu\text{F}$). Diode D₁ prevents C_o Adj from discharging through the IC during an input short circuit. Diode D₂ protects against capacitor C discharging through the IC during an output short circuit. The combination of diodes D₁ and D₂ prevents C from discharging through the IC during an input short circuit. The modification circuit as figure 5. The formula

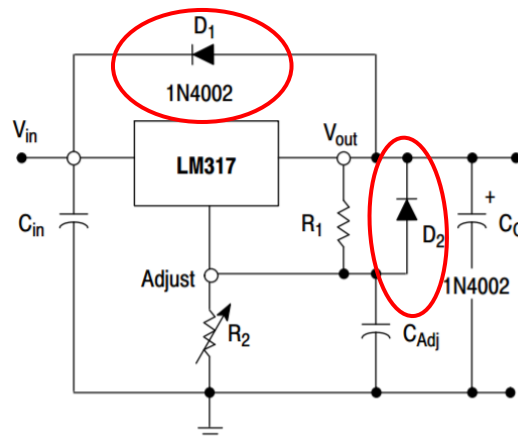

Figure 5. The basic circuit with diode modified

Table 2. Simulation results using slider motor

Distance (cm)	120	120	120	120
Voltage	3.4	8.3	11.7	16.5
Speed Time	25'97''	20' 11''	10'3''	6'51''

If the voltage applied to the motor is getting low, will produce motor movement slowly so that cameras are used to move slowly and the video motion effect will be produced, but if the voltage applied to the motor is high (in this case a maximum of 24 Volts) the motor movement into normal even faster, and motion video effect will not be generated. Symbol m meaning minutes, the symbol s means seconds.

5. Conclusion

It is important to modify the basic circuit using a diode to protect IC to be long life the motor and ensure the battery full charge and also to prevent the capacitors from discharging through low current points into the regulator IC. The research by User Acceptance Testing (UAT), applications can be received very well by the validator, and also suggests that slider motor can be supported to make synthetic video motion. This may be more suited to make video e-learning. The motor slider is overall valuable and well accepted educational tools to create slow motion video and the video results can be video training.

References

- [1] Anonymous, *ON Semiconductor LM317, NCV31*, www.onsemi.com
- [2] Davis F D 1989 Perceived Usefulness, Perceived Ease of Use, and User Acceptance of Information Technology, *MIS Quarterly* **13** 3 p 319-340
- [3] Barret H 2000 Create Your Own Electronic Portfolio, *Learning & Leading with Technology* **27** 7 p 14-21
- [4] Hovland C I, Lumsdaine A A and Sheffield F D 1949 *Experiments on mass communication* (Princeton, NJ: Princeton University Press)
- [5] Mayer R E 2001 *Multimedia learning* (Cambridge: Cambridge University Press)
- [6] Miller P 2001 Learning styles: Multimedia of the mind (ERIC Document Reproduction Service No. ED 451 140)
- [7] Wibawa S C 2013 Creative Industry Collaboration for The Creative Portfolio *International Conference on Creative Industry (ICCI)* p 265-367
- [8] Wibawa S C, Beauty Media Learning using Android Mobile Phone *International journal publish on www.ijirae.com* 2349-2163 **2** 11
- [9] Wibawa S C and Gareca C 2014 Students' Creative e-Portfolio: Using Android Cellphone Cameras for Inventive Beauty Photography *Proceeding International Conference on Advances in Education Technology (ICAET 2014)* p 121-124
- [10] Wibawa S C, Wahyuningsih Y, Sulistyowati R, Abidin R, Lestari Y, Noviyanti and Maulana D A 2018 Online test application development using framework CodeIgniter *IOP Conf. Series: Materials Science and Engineering* **296**
- [11] Wibawa S C, Cholifah R, Utami A W and Nurhidayat A I 2018 Creative Digital Worksheet Base on Mobile Learning *IOP Conf. Series: Materials Science and Engineering* 288-012130